

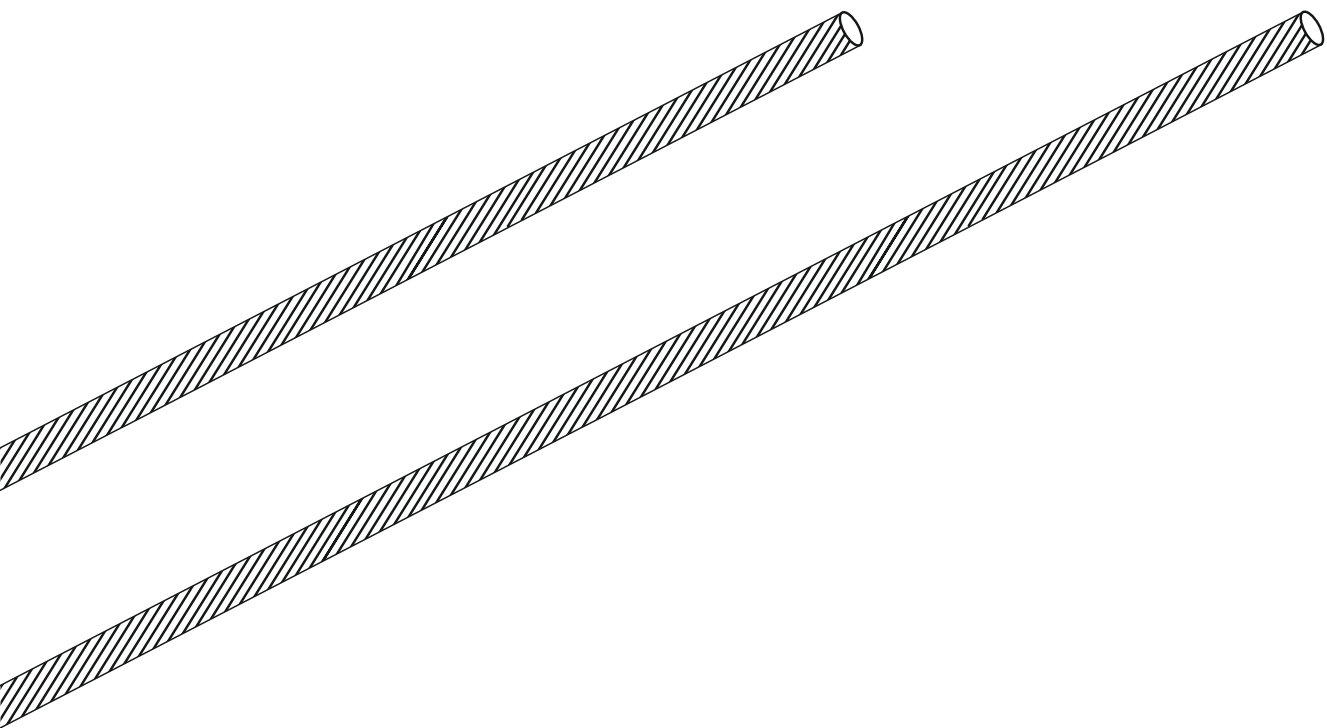

HIGH-LINE 12 V - SEILSYSTEM
HIGH-LINE 12 V - CABLE SYSTEM





HIGH-LINE 12 V - SEILSYSTEM HIGH-LINE 12 V - CABLE SYSTEM

Vielseitige Montagemöglichkeiten

Ob die Montage an Decke, Wand oder Boden erfolgen soll, ob an geraden oder schrägen Wänden, ob die Seile umgelenkt oder Figuren realisiert werden sollen, HIGH-LINE bietet vielseitige Montagemöglichkeiten um Ihre ganz individuelle Planung zu realisieren.

Garantiert kein Durchhängen

Die HIGH-LINE Seile mit dem Kevlarfaden von BRUCK verhindern das Durchhängen bei über 5 m Leitungslänge. Die Montagesets VARIO KOMFORT HLI, KOMFORT HLI und VARIO STANDARD HLI haben serienmäßig pro Seil zwei Spannelemente. So hat Ihr HIGH-LINE Seilsystem von BRUCK garantiert keinen Durchhängen.

Many different layout options

HIGH-LINE provides versatile layout options to help you realise your individual lighting plans, whether you are mounting the system on the ceiling, wall or floor, on straight or sloping walls, or whether you want the cables to change direction or create figures.

Guaranteed sag-free

HIGH-LINE cables with their kevlar core from BRUCK can span distances of up to 5 m without sagging. Should a cable ever show signs of sagging, it can be easily tightened again with the tensioners. The mounting sets VARIO KOMFORT HLI and VARIO KOMFORT STANDARD HLI have two tensioners per cable. So your HIGH-LINE cable system from BRUCK is guaranteed to stay sag-free.



LOFT SPOT HLI 150293ch

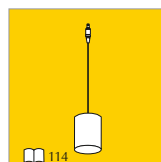

114



145

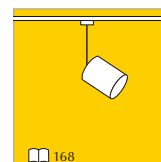

168

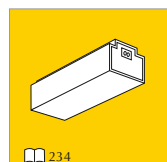

234





HIGH-LINE 12 V - SEILSYSTEM HIGH-LINE 12 V - CABLE SYSTEM

MONTAGESETS MOUNTING SETS

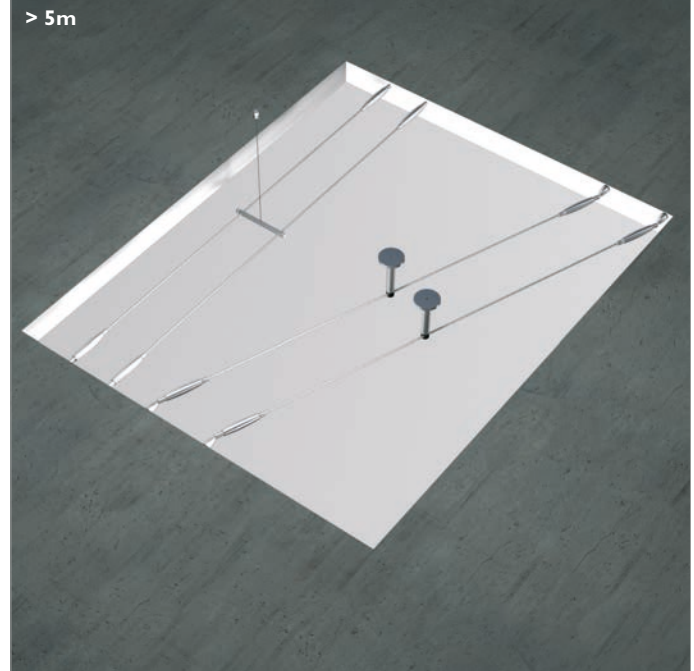

VERBINDER CONNECTOR

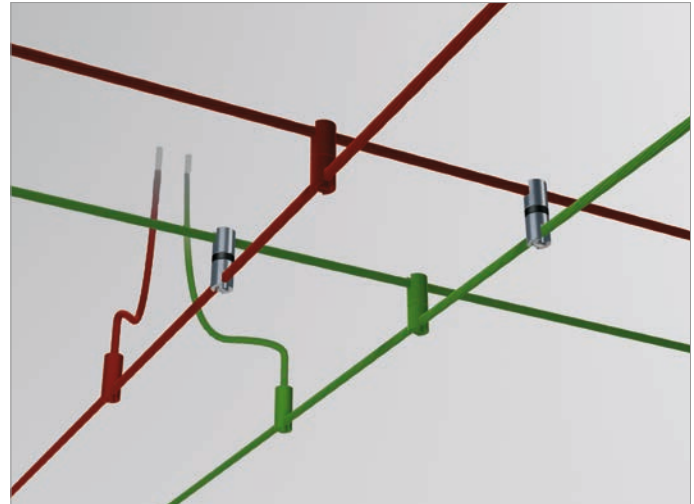
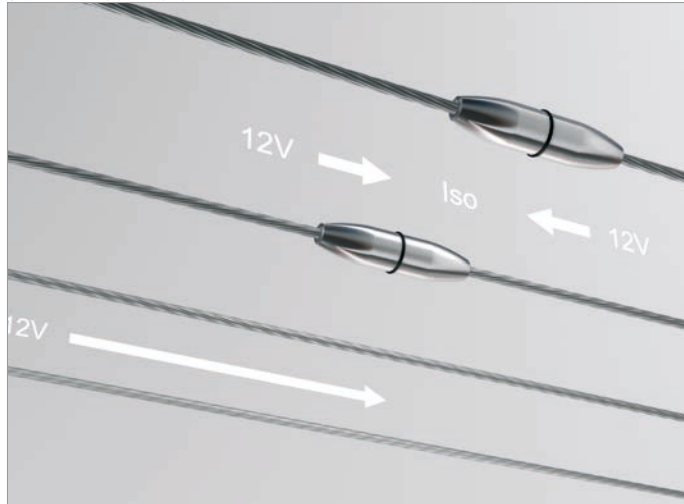

BEFESTIGUNG / UMLENKER FIXATION / REROUTER



UMLENKER REROUTER



EINSPEISUNG POWER FEED

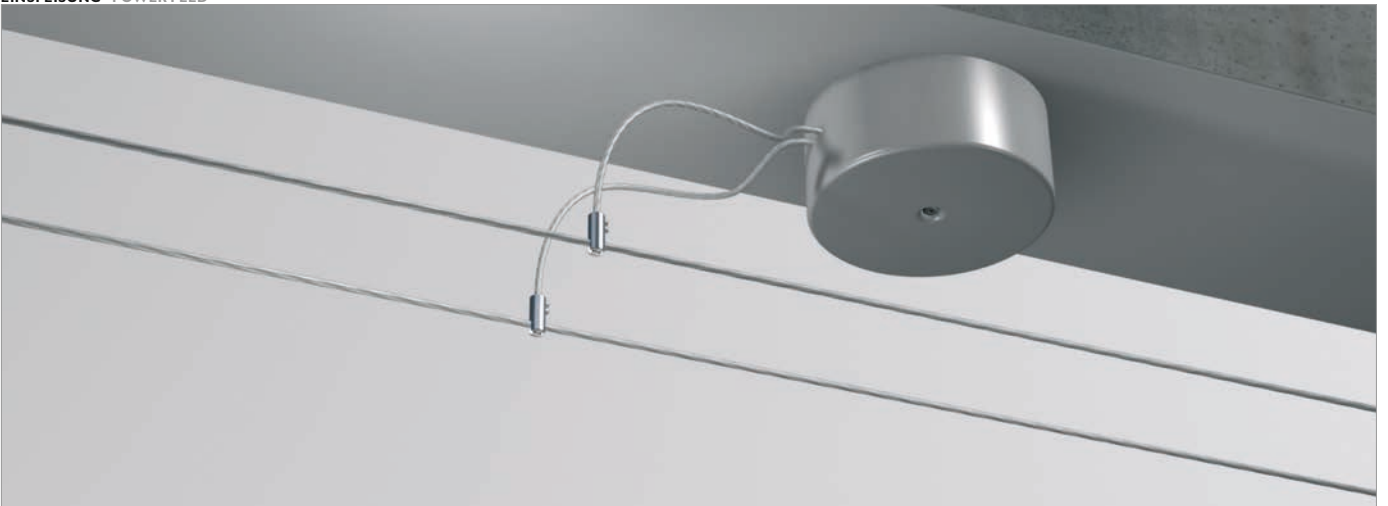

ADAPTER ADAPTER

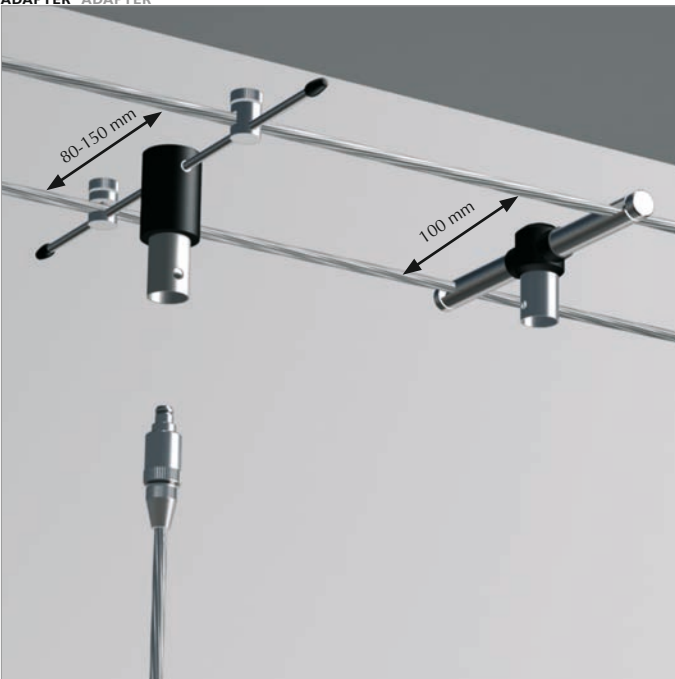



HIGH-LINE 12 V - SEILSYSTEM

HIGH-LINE 12 V - CABLE SYSTEM

KUPFERLEITER TINNED COPPER CABLE

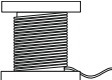

max.
12 V

III

max.
400 W

1

Preis pro laufendem Meter
Price per metre



4 mm² KEVLAR

6 mm² KEVLAR

150109



blank mit Kevlar
bare with kevlar

150113



blank mit Kevlar
bare with kevlar

4 mm² KEVLAR ISO

6 mm² KEVLAR ISO

150119



transparent isoliert mit Kevlar
transparent isolation with kevlar

150122



transparent isoliert mit Kevlar
transparent isolation with kevlar

MONTAGESET MOUNTING SET für Installationslängen bis 5,0 m for installation lengths up to 5.0 m

MONTAGESET MOUNTING SET VARIO STANDARD HLI



für gerade und schräge Montageflächen, isoliert zur Montagefläche, mit: 4 x Spannelement, Montagematerial, Einspeisung und 1m Anschlussleitung 4 mm²
for straight and sloping surfaces, insulated towards the mounting surfaces, including: 4x tensioners, installation material, power feed, power feed cable 4 mm², length 1 m

150501ch 

150501mc 



| 120-150 |

MONTAGESET MOUNTING SET ECO HLI



für gerade und schräge Montageflächen, isoliert zur Montagefläche, mit: 2 x Spannelement, 4 x Wandhaken, 4 x Seilklemme, Montagematerial, Einspeisung und 1 m Anschlussleitung 4 mm²
for straight and sloping surfaces, insulated towards the mounting surfaces, including: 2x tensioners, 4 x wall hooks, 4 x cable clips, installation material, power feed, 1 m power feed cable 4 mm²

150500ch 



| 60-150 |



MONTAGESET MOUNTING SET für alle Installationslängen bis max 15m for all installation lengths until max. 15m
MONTAGESET MOUNTING SET VARIO HLI



für gerade und schräge Montageflächen, isoliert zur Montagefläche, mit: 2 x Spannelement, 2 x Seilhalter, Montagematerial, Einspeisung und 1 m Anschlußleitung 4 mm² for straight and sloping surfaces, insulated towards the mounting surfaces, including: 2x tensioners, 2 x cableholders, installation material, power feed, 1 m power feed cable 4 mm²

150518ch
150518mc

MONTAGESET MOUNTING SET VARIO COMFORT HLI



für gerade und schräge Montageflächen, isoliert zur Montagefläche, mit: 4 x Spannelement, Montagematerial, Einspeisung und 1 m Anschlußleitung 4 mm² for straight and sloping surfaces, insulated towards the mounting surfaces, including: 4x tensioners, installation material, power feed, 1 m power feed cable, 4 mm²

150522ch
150522mc

BEFESTIGUNG FIXATION
2 X SPANNELEMENT 2 X TENSIONER VARIO COMFORT HLI



Für gerade und schräge Montageflächen, isoliert zur Montagefläche, 2 tlg. for straight and sloping surfaces, insulated from mounting surface, 2 pcs.

150535ch
150536mc

2 X SPANNELEMENT 2 X TENSIONER COMFORT HLI



für gerade Montageflächen oder zur Montage an Befestigung C/W, 1 Paar for straight surfaces or for mounting on C/W attachment, 1 pair

150530ch
150531mc

2 X SPANNELEMENT 2 X TENSIONER ISO HLI



zur isolierenden Seiltrennung, für gerade Montageflächen oder zur Montage an Befestigung C/W, 1 Paar for cable isolation, for straight mounting surfaces or for mounting on C/W attachment, 1 pair

150524ch
150524mc

2 X SEILHALTER 2 X CABLE HOLDER HLI



isoliert zur Montagefläche, für Installationslängen bis max. 5,0 m, 1 Paar insulated from mounting surface, for installation lengths up to 5 m, 1 pair

150150ch
150160mc

KREUZUNGSPUNKT CROSS CONNECTOR ISO HLI



für kreuzende Kupferleiter, isolierend, 1 Stück for crossing copper conductors, insulating, 1 piece

150512ch
150512mc

KREUZUNGSPUNKT CROSS CONNECTOR HLI



für kreuzende Kupferleiter, 1 Stück for crossing copper conductors, 1 piece

150513ch
150513mc



HIGH-LINE 12 V - SEILSYSTEM HIGH-LINE 12 V - CABLE SYSTEM

BEFESTIGUNG FIXATION WANDPLATTE WALL PLATE HLI



zur Vergrößerung der Auflagefläche bei Leichtbaudecken und Wänden, 1 Stück, in Kombination mit Montageset VARIO KOMFORT HLI, VARIO HLI, VARIO STANDARD HLI, Spannelement VARIO oder Seilhalter HLI
increases the support area of plasterboard ceilings and walls, 1 piece, in combination with mounting set VARIO KOMFORT HLI, VARIO HLI, VARIO STANDARD HLI, the VARIO tensioner or HLI cable holder



| 52 |

150525ch
150526mc



BEFESTIGUNG C/W 50 HLI FIXATION C/W 50 HLI

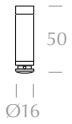

150800ch
150800mc



inkl. 2 verschiedener ISO-Umlenkköpfe, 1 Stück
incl. 2 different ISO rerouter, 1 piece

BEFESTIGUNG C/W 180 HLI FIXATION C/W 180 HLI



150840ch
150840mc



inkl. 2 verschiedener ISO-Umlenkköpfe, 1 Stück
incl. 2 different ISO rerouter, 1 piece

BEFESTIGUNG C/W 100 HLI FIXATION C/W 100 HLI

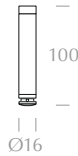

150810ch
150810mc



inkl. 2 verschiedener ISO-Umlenkköpfe, 1 Stück
incl. 2 different ISO rerouter, 1 piece

ZUSATZSTÜTZE I HLI ADDITIONAL SUPPORT I HLI



150545ch
150545mc



Für Befestigung C/W 180 und 280 mit 52 mm Fußdurchmesser, nicht kürzbare Gelenkstange
for C/W FIXATION 180 and 280 with 52 mm base diameter, hinged suspension rod can not be shortened



ABHÄNGUNG 100 HLI CABLE SUSPENSION 100 HLI

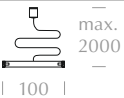

150516ch
150516mc



gegen Durchhängen längerer Seilssysteme > 5m mit Seilabstand 100 mm, inkl. 2 m Stahlseil, kürzbar
avoids sagging of long cable systems > 5m with 100 mm cable distance, incl. 2 m steel cable, can be shortened

ABHÄNGUNG 80-150 HLI CABLE SUSPENSION 80-150 HLI

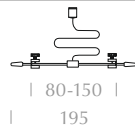

150528ch
150528mc



gegen Durchhängen längerer Seilssysteme mit Seilabstand 80-150 mm, inkl. 2 m Stahlseil, kürzbar
avoids sagging of long cable systems with 80-150 mm cable distance, incl. 2 m steel cable, can be shortened

BEFESTIGUNG FIXATION
UMLENKER C/W HLI RE-ROUTER C/W HLI



C/W HLI

150180ch

EINSPEISUNG POWER FEED

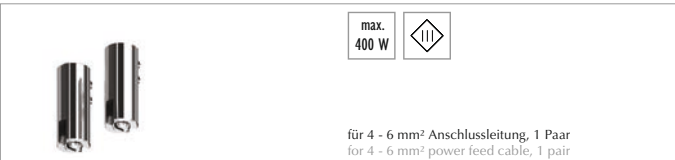

150514ch
150514mc

ADAPTER ADAPTER



100 HLI-PNT

150360ch
150360mc

horizontal / vertikal, Seilabstand 100 mm
 horizontal / vertical, 100 mm cable distance

80-150 HLI-PNT

150390ch
150390mc

horizontal / vertikal, Seilabstand 80-150 mm
 horizontal / vertical, 80-150 mm cable distance



HALO

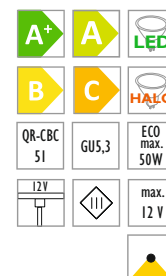
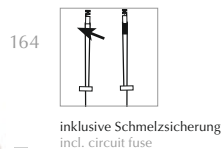

LOFT MOVE DOWN HLI Design: Achim Bredin

150291ch  W
150291mc  W



HALO

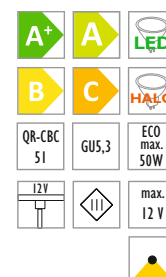

CALO DOWN-C HLI

150249ch 
150249mc 





HALO

CALO KROKOMOBIL SPOT HLI

120 mm
150205ch 
150205mc 



250 mm
150206ch 
150206mc 

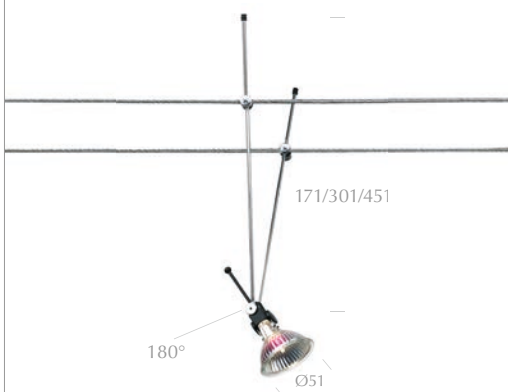

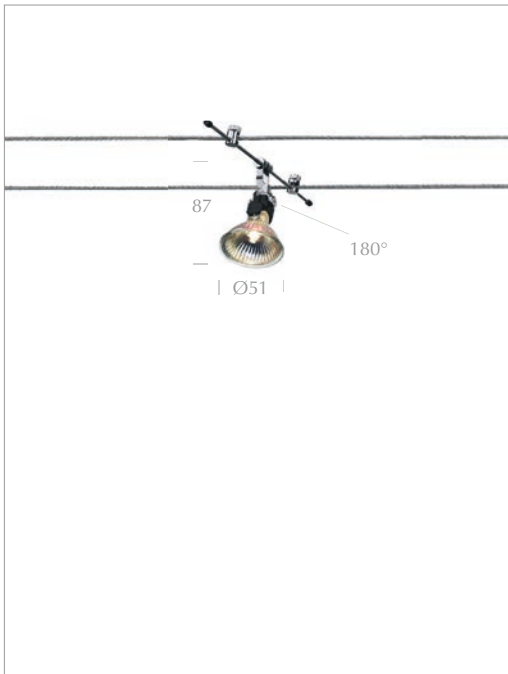
400 mm
150207ch 
150207mc 





CALO SPOT MINI HLI Design: Martin Kania



150400ch 
150400mc 



A+	A	LED
B	C	HALO
QR-CBC 51	GUS,3	ECO max. 50W
12V		max. 12 V
		



HALO

CALO SPOT QR III HLI Design: Martin Kania

150401ch 
150401mc 

A+	A	LED
B	C	HALO
QR-LP 111	G53	ECO max. 65 W
12V		max. 12 V
		



HALO

CLASSIC MICRO SPOT HLI

150600ch 
150600mc 

A+	A	LED
B	C	HALO
QR-CBC 51	GUS,3	ECO max. 50W
12V		max. 12 V
		

HALO

LOFT DOWN-C HLI Design: Achim Bredin

150295ch W
150295mc W

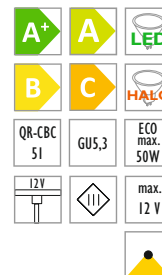

HALO

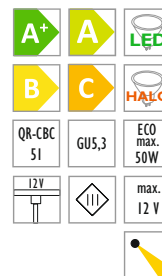

LOFT SPOT HLI Design: Achim Bredin

150293ch W
150293mc W



HALO

STAR RONY SPOT HLI

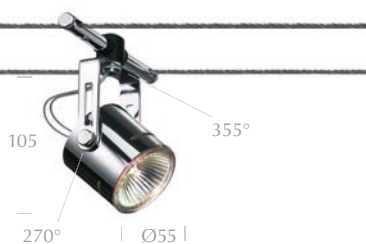

150280ch 
150280mc 



HALO



WING UP HLI Design: Andreas Struppler

150765ch 
150765mc 

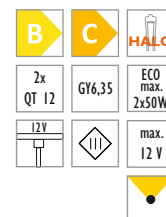

HALO



CLASSIC GLOW HLI

150218ch 
150218mc 