



AVANGARDO

.hess

WWW.HESS.EU/AV2



LIGHTING BY HESS TO ACCENTUATE AND HIGHLIGHT

For decades, Hess has been bringing light to towns, cities, communities and buildings – both inside and out. Luminaires by Hess stand out for their well-engineered lighting technology, high product quality, maintainability and timeless design idiom. The Hess philosophy is to apply our experience and knowledge to creating new luminaires in contemporary designs, while continually making improvements.

NEW WAYS TO USE LIGHTING IN WALL DESIGN

The successful AVANGARDO range has been setting standards in outdoor and building lighting for over 20 years. Revised and updated, the collection now features modular LED technology in the proven AVANGARDO design. A comprehensive portfolio comprising multiple product families and numerous variants caters for an array of different lighting requirements.

PRODUCT OVERVIEW



FIDENZA
46-49

PADUA
50-53

GENUA
54-57



100%
LED



CARINI
58-61



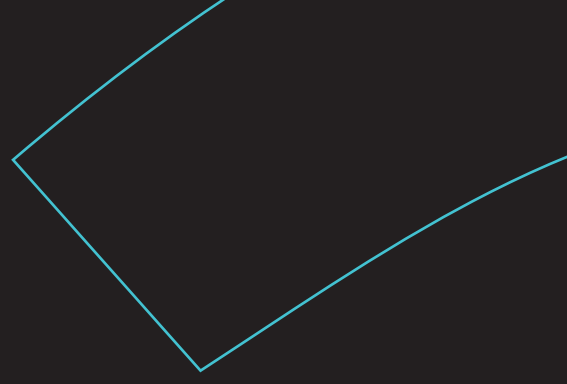

FERRARA
62-65

CENTO
66-69

CASSINO
70-73

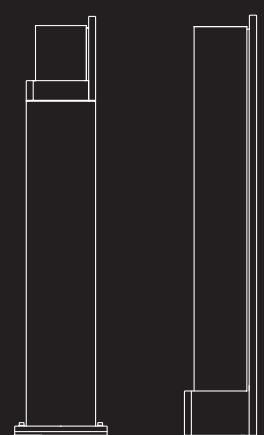
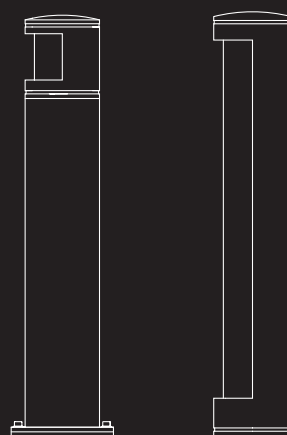
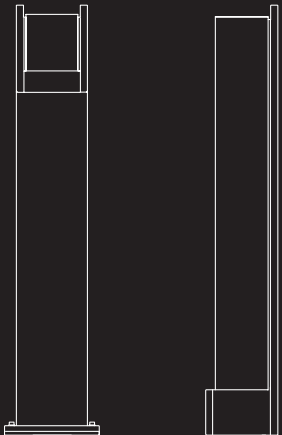

100%
LED

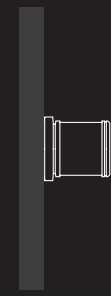

TRENTO
74-77

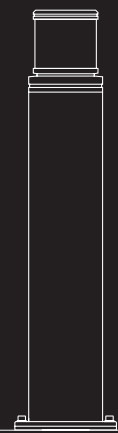

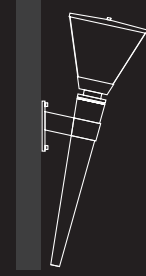
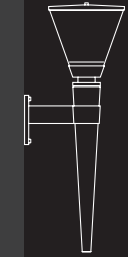
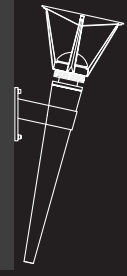
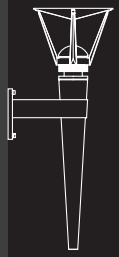

100%
LED

AMALFI
78-81

PARMA
82-85

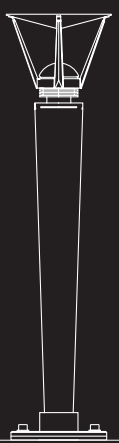

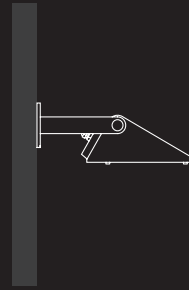
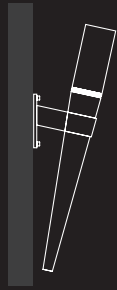

RIVA
86-89

NOVARA
90-93

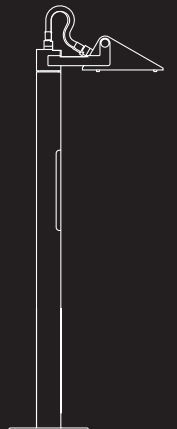
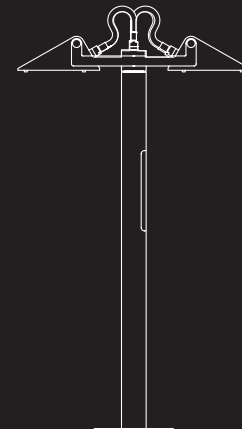

SALINA
94-97

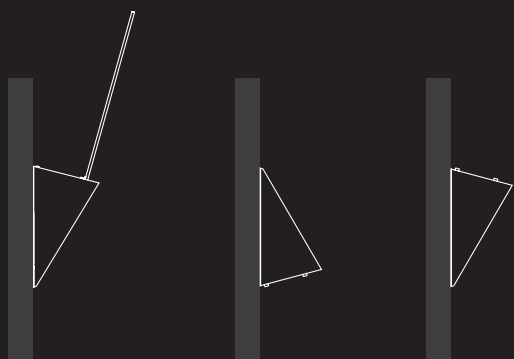

BARI
98-103

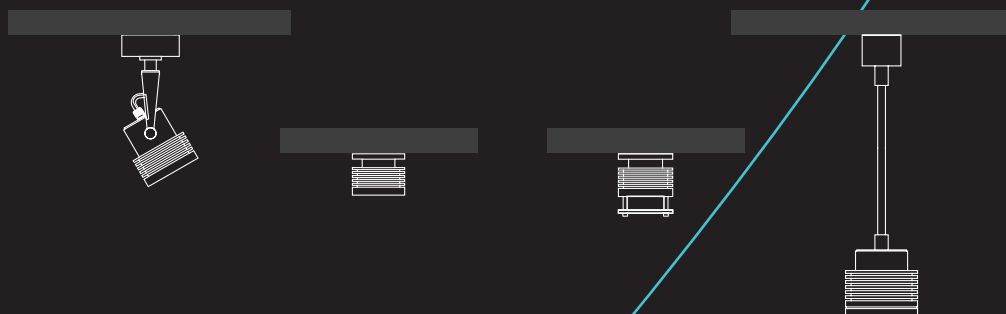

100%
LED

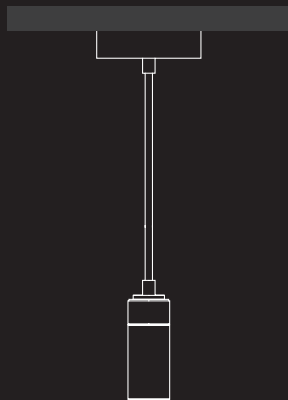

MESSINA

104-107

SAVONA

108-109



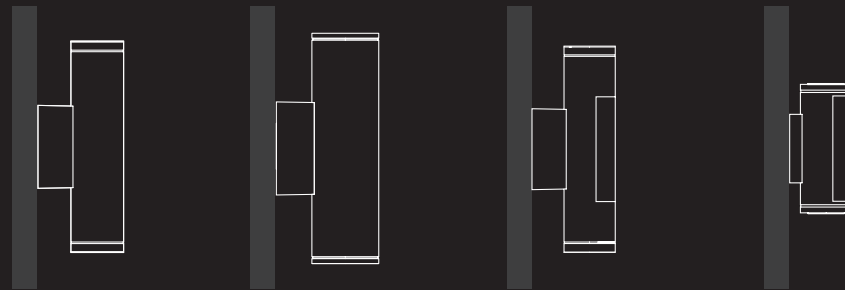

SEDI
110-113

VARELLO
114-117

ARCUS
118-121

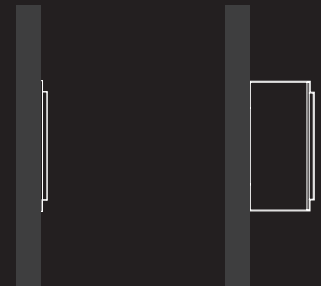

100%
LED

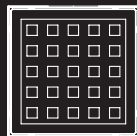

LEDIA Q/R
122-125

LEDIA LF
126-127

RAVENNA
132-135

LEDIA LL
128-131





HESS – WE DESIGN CITIES

Thanks to an extremely varied range of luminaires, Hess is able to fulfil every lighting design requirement in outdoor public spaces, as well as illuminating buildings both inside and out. Perfectly matching, high-quality street and site furnishings complete the product portfolio.

Light and form are part of our company name, and thus firmly anchored in our corporate philosophy and our very genes. Hess stands for the very best lighting solutions and an unparalleled expression of design. The combination of light and form is what makes our products unique.

Combining lighting and furnishings to optimum effect allows **integrated concepts** and **special customised solutions** to be implemented across urban and outdoor spaces in line with our slogan „Designing cities“.

Hess is a leading international brand built on a **design**-led blend of **innovation** and **tradition**. We support and assist architects, planners, cities, municipalities and building owners from the planning stage through to installation – throughout Europe and beyond.

With the main factory located in Villingen-Schwenningen (Germany), there are also manufacturing operations in Gaffney, South Carolina (USA). Hess has been a subsidiary of the Nordeon Group since 1 October 2013.

Our focus on high-quality materials, traditional craftsmanship and independent stylistic elements results in designs of distinction, day after day. Uniquely made by Hess.

Hess. Designing cities.

Bench . CORVUS
Luminaire . CITY ELEMENTS
Tree grate . OCTA
Spot projector . RAVENNA . SEDI

PERFECT LIGHTING

Lighting provides security, helps people to find their way and creates atmosphere. Light also promotes a sense of well-being.

These days, lighting is a key factor when it comes to improving people's living environments and quality of life. Lighting allows cities, towns and communities to differentiate themselves and to enhance their attractiveness.

Building on decades of experience and expertise, we provide lighting for any purpose, occasion and place.

The very best lighting.

Lighting by Hess.





LIGHT AND TECHNOLOGY

Hess delivers efficiency in the most attractive form. LED luminaires by Hess **consume less power** and thereby reduce CO₂ emissions along with energy costs. Economy is also considerably improved by the long service life of products and low maintenance expense.

We are able to achieve the desired lighting result through ingenious design and **optimum optical light control**.

Hess LED products are state of the art, offering low glare and good thermal management. We have also separated LED technology from optical light control. This allows luminaires to be effortlessly upgraded to meet the latest technical standards, while simultaneously keeping costs and effort low. It also takes into account the very short cycles of innovation associated with LED illuminants.

Our optimised reflector technology supports **conventional luminaires** and energy-efficient operation.

Hess provides lighting to suit every situation and requirement. The very best lighting.

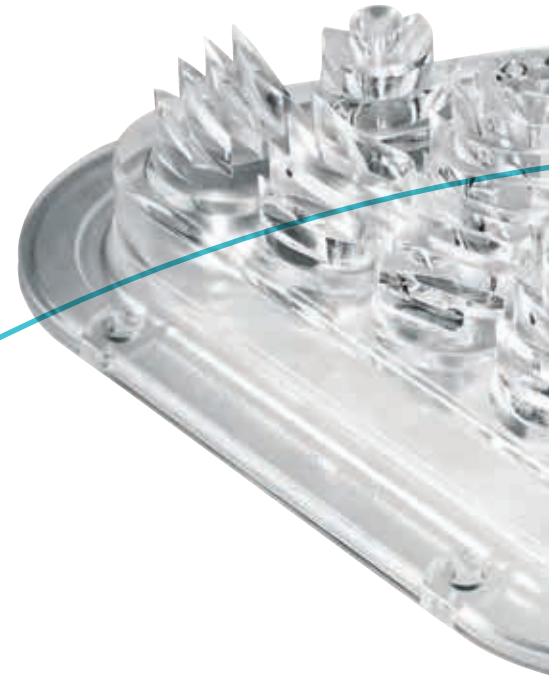



LEVO

From streets to squares, from illuminating columns to pole top mounted or bracket mounted luminaires – by deploying special lenses and arranging LEDs in multiple configurations, the LEVO module is highly flexible and complies with a range of lighting classes.



XICATO

XICATO is a high-performance LED module. The special remote phosphor technology behind it ensures superior characteristics, such as very high colour fidelity, for example, throughout the product's service life. Superior colour rendering is a distinctive feature here, with a colour rendering index (CRI) of 80+.

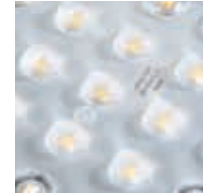

LEVO Q

High-performance cluster LEDs on an interchangeable carrier. The reflector and prismatic glass are separate components which distribute and direct the light in an even, precise and glare-free way.



RAP MODULE

The RAP module from OSRAM combines pioneering LED technology with forward-looking lighting to meet the highest standards. Hess luminaires combined with the OSRAM LED module are ideal for a host of lighting requirements on streets, squares and pedestrian crossings.



cLED AND cLED EASY

LED retrofit modules for heritage luminaires. Thanks to the bulb optics and warm light colour, these modules fit harmoniously into historic Old Town districts and make it easy to replace the mercury-vapour lamps, which are often still in use. Heritage lighting made by other manufacturers can also be converted using cLED easy.

Facet element

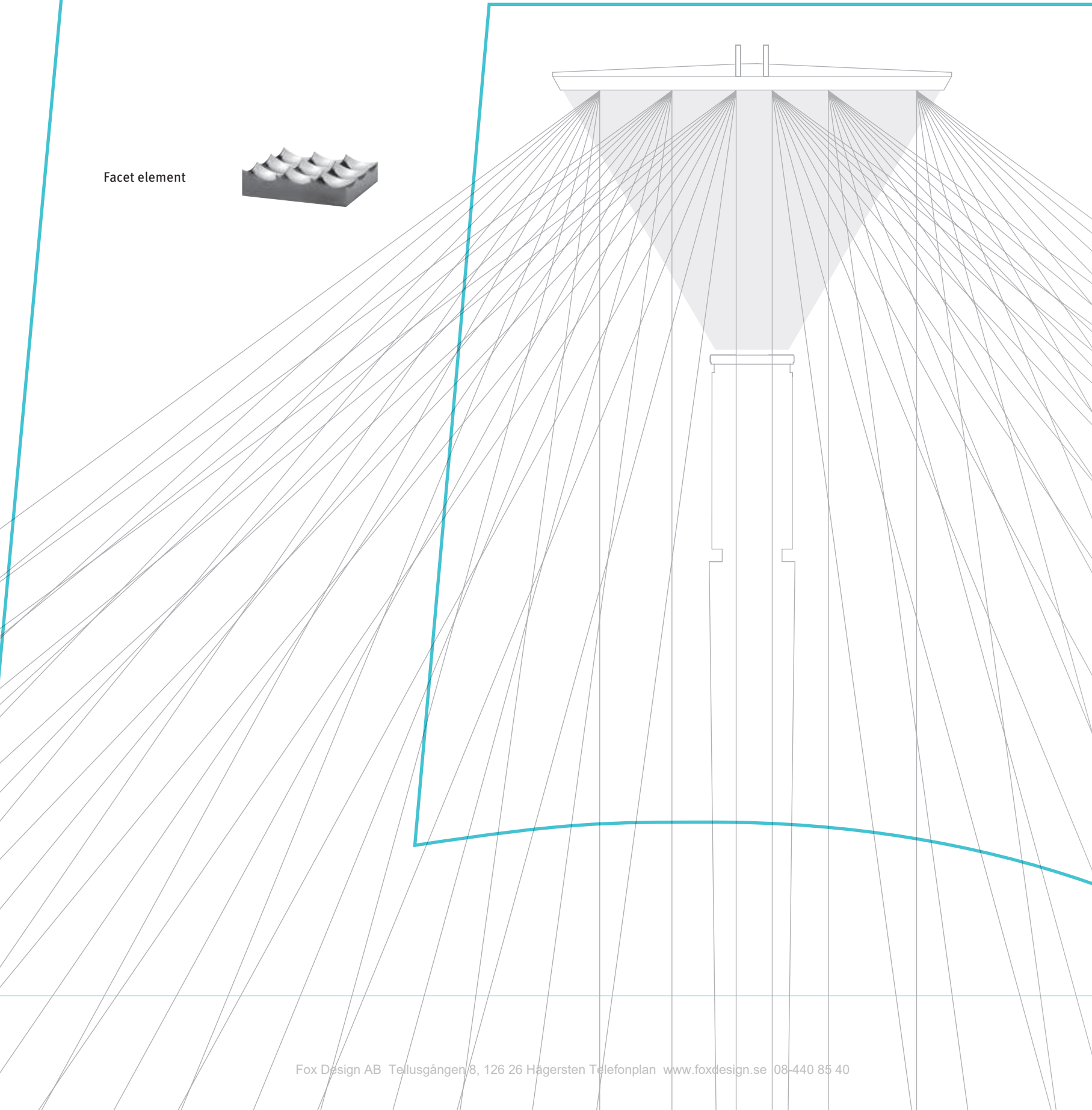

LIGHT BEAM IMAGE SPLITTING

GLARE - FREE

High illumination levels almost without glare are made possible by the principle of **light beam image splitting**. Light from one or more floodlights is directed onto a mirrored surface containing many individual mirror facets.

The mirrored surface acts as a secondary reflector and distributes light onto the area for illumination very evenly and in a targeted way.

MULTI - FACETED

In order to illuminate a street or square to perfection, mirrored surfaces are fitted with **various facet shapes**. Similar facet shapes can also be used in different ways to focus light onto the mirrored area.

BRILLIANT

The fronts of special plastic facet are metallised using **pure aluminium**. As a result, the light does not need to pass through diffuse plastic. This increases efficiency and the precision of light direction. A multi-layer protective seal gives the mirrored surface its rugged quality.

CUSTOMISED

VEDO and FARO luminaires make **customised solutions** possible in various lighting situations – from small or large squares to combined square and street lighting, as well as illumination for roads and footpaths. Additional illumination is available for building facades.

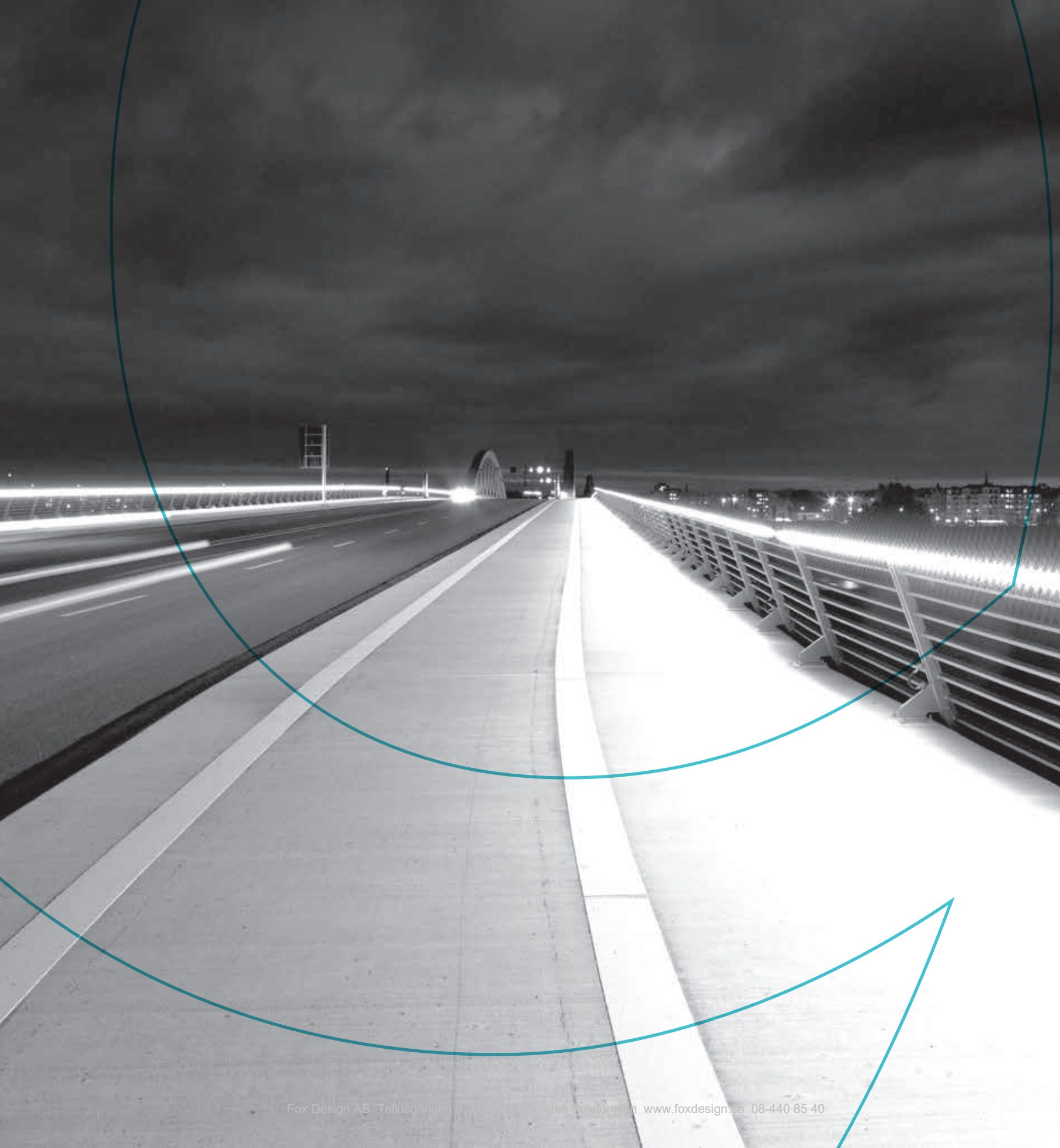



LEDIA LF

DIFFERENT BY DESIGN

For atmosphere, structure and illumination. From arcades to squares and water features. Our illuminating strips and tiles help to create atmosphere, provide structure and produce impressive illuminations. **Areas** can be clearly differentiated with their **own structure** and **design characteristics**.

IDEAL SOLUTION

A suitable set for every type of building. Different kinds of buildings require different illumination solutions, which may be either horizontal or vertical in alignment. Hess provides the ideal solution for **illuminating** and **accentuating** any building.

SCOPE FOR CREATIVITY

LEDs open up a **wider range of creative options** when it comes to architectural lighting. Small, efficient, long-lasting and requiring virtually zero maintenance, they are available in various shades of white or controllable colour.

Hess LED lighting effects are more than just a decorative element.

LEDIA LL



HESS SHOWPLACES – NOTHING IS MORE COMPELLING THAN REALITY

We are well aware that paper is a forgiving medium.
That is why our two sites in Villingen and Gaffney both include a showplace.

These locations bring lighting to life. Prepare to be inspired
by the design, quality and diversity of our luminaires and site furnishings.

We look forward to welcoming you.

Hess showplaces – bringing light to life



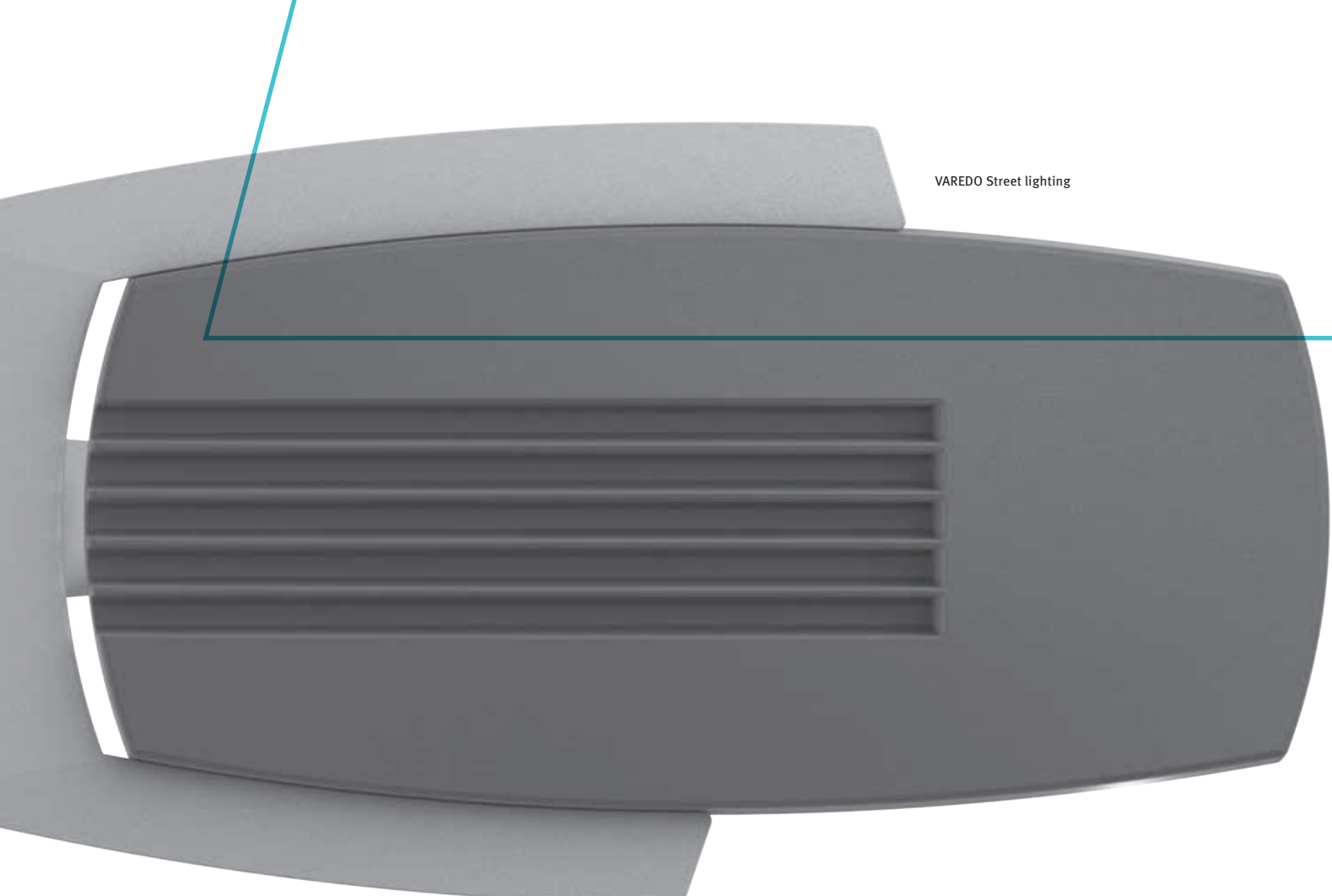

VAREDO Street lighting

PERFECT COMBINATION

Luminaires and site furnishings

By combining luminaires and site furnishings in the ideal way, we facilitate integrated solutions and a holistic approach to the design of urban spaces.

Our customised solutions are perfect for creating individual looks.

Hess. Integrated. Customised.



SERA Street lighting



VAREDO Bicycle rack

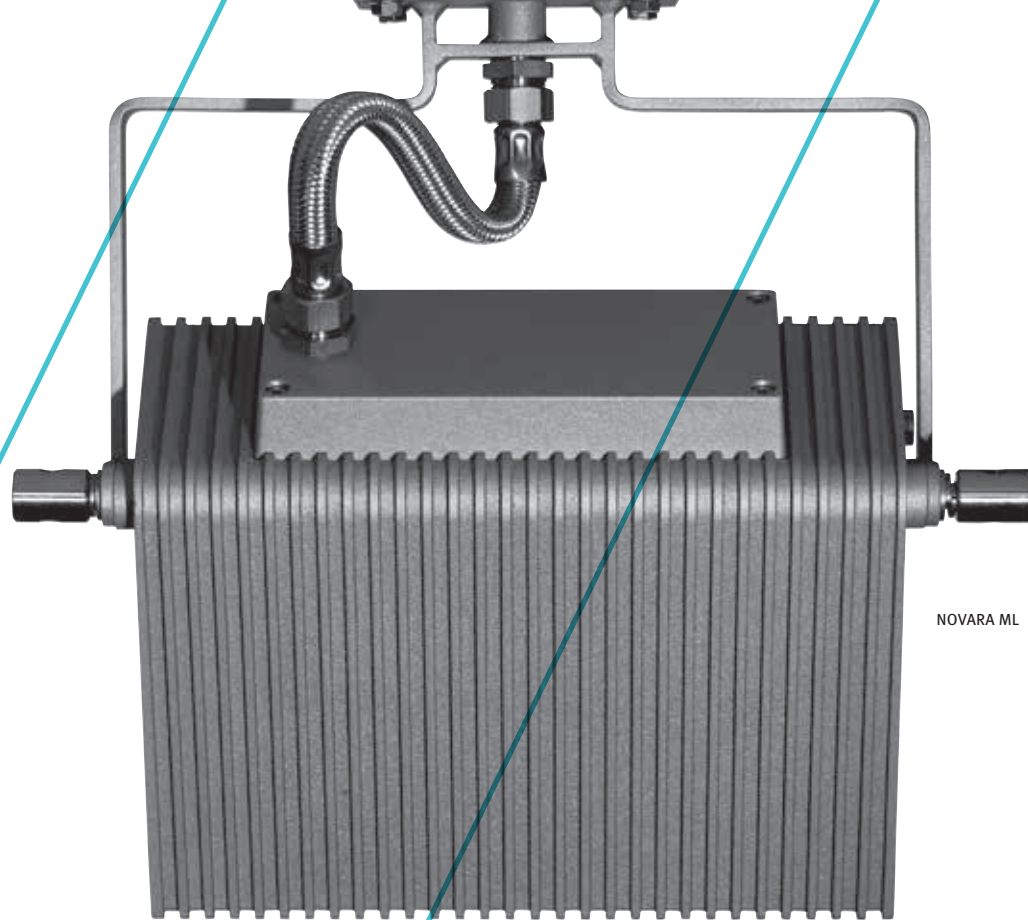

NOVARA ML

STYLE ELEMENTS

Hess products are unparalleled in terms of their expression of design, look and feel.

We work closely with **selected designers** to develop luminaires and street and site furnishings for creating urban spaces. Our luminaires and site furnishings last for decades.

Hess products are able to withstand even the toughest conditions for long periods of time. Because we select and work with **high-quality materials**, our products have a typical Hess look featuring an unparalleled finish. Sophisticated processing techniques ensure the best possible resistance to weather conditions and corrosion. Comprehensive product families are available in a range of different sizes, offering the perfect solution for any application. Ideal form, ideal proportions.

Hess. Exclusive design and quality.



CORVUS



HESS. A FULL-SERVICE, CONTEMPORARY PROVIDER

Hess is a **turnkey solution provider**, delivering the perfect combination of luminaires and suitable site furnishings for designing urban spaces.

Efficient lighting solutions stem from an integrated lighting design process. Our specialists assist with the necessary lighting calculations and are able to advise on choosing the right illuminant, reflector and control system for both outdoor and indoor applications.

Using our proprietary optical systems we will divert light to where you want it and to where it is needed. Precisely and effectively.

We are your expert, one-stop partner for all lighting solutions.
Hess. From the planning stage through to implementation.
From idea to finished product.

Hess. Customer focus par excellence.



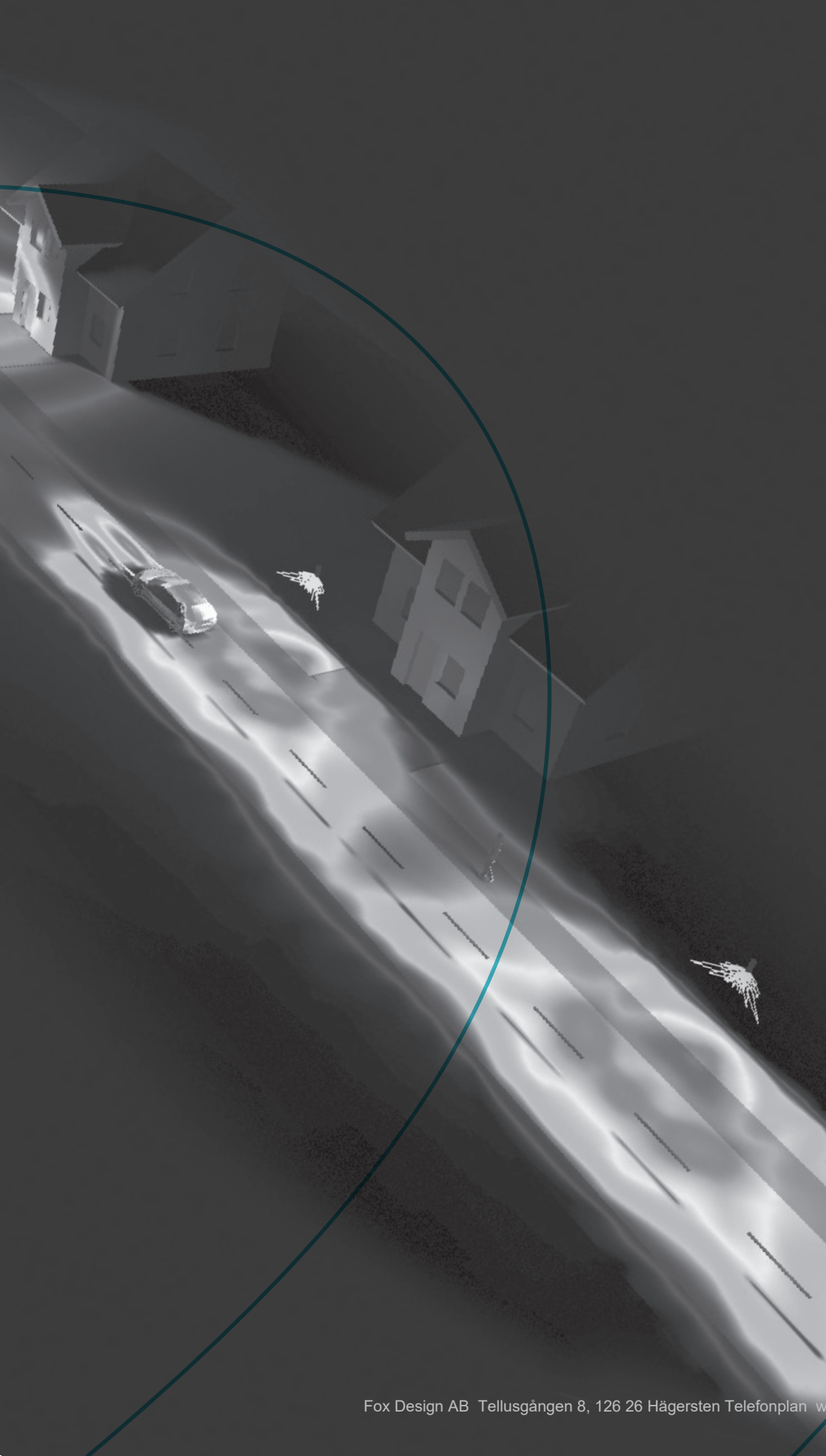

HESS COMBINES FORM AND FUNCTION – WITH CITY ELEMENTS

City Elements offer architects and urban planners a comprehensive lighting system to answer virtually every lighting need and more.

Because the **individual elements** can be **combined** as desired, the system **enables** a variety of **supply options**. Solutions include water supply, CCTV cameras and other inner-city requirements. The supply of power is, of course, a further possibility to meet the rising demand for e-mobility.

With three different column diameters and variable heights up to 9 m, City Elements work with existing proportions and fit perfectly into the urban environment.

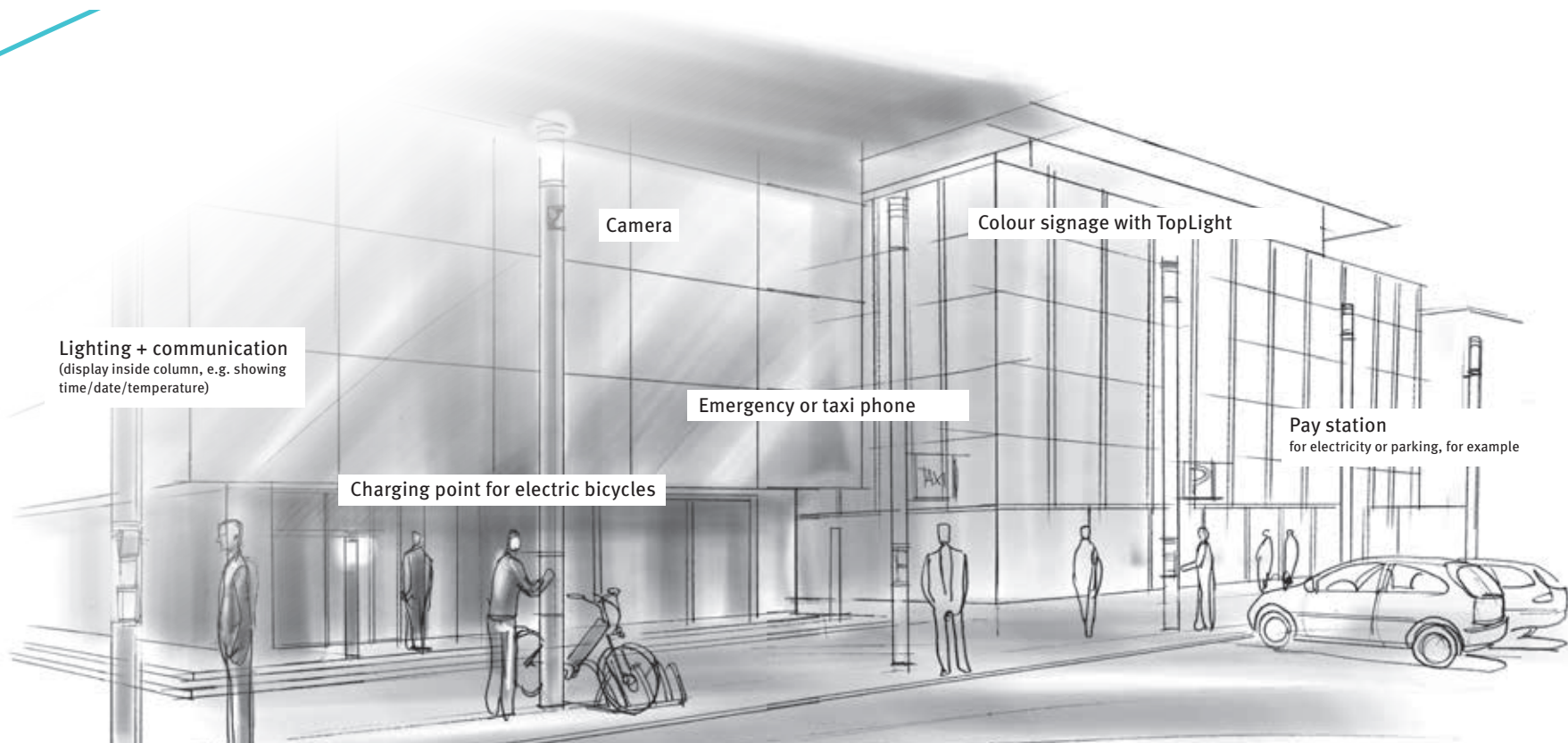

CITY ELEMENTS EVOKE EMOTION

The ability to **customise** the **colour scheme** of illuminating columns can intensify emotions. Colour is a powerful design element. Colour adds character and is a truly urban element. Which makes colour a City Element.

Which colour will you choose?

City Elements by Hess. Maximum multi-functionality.

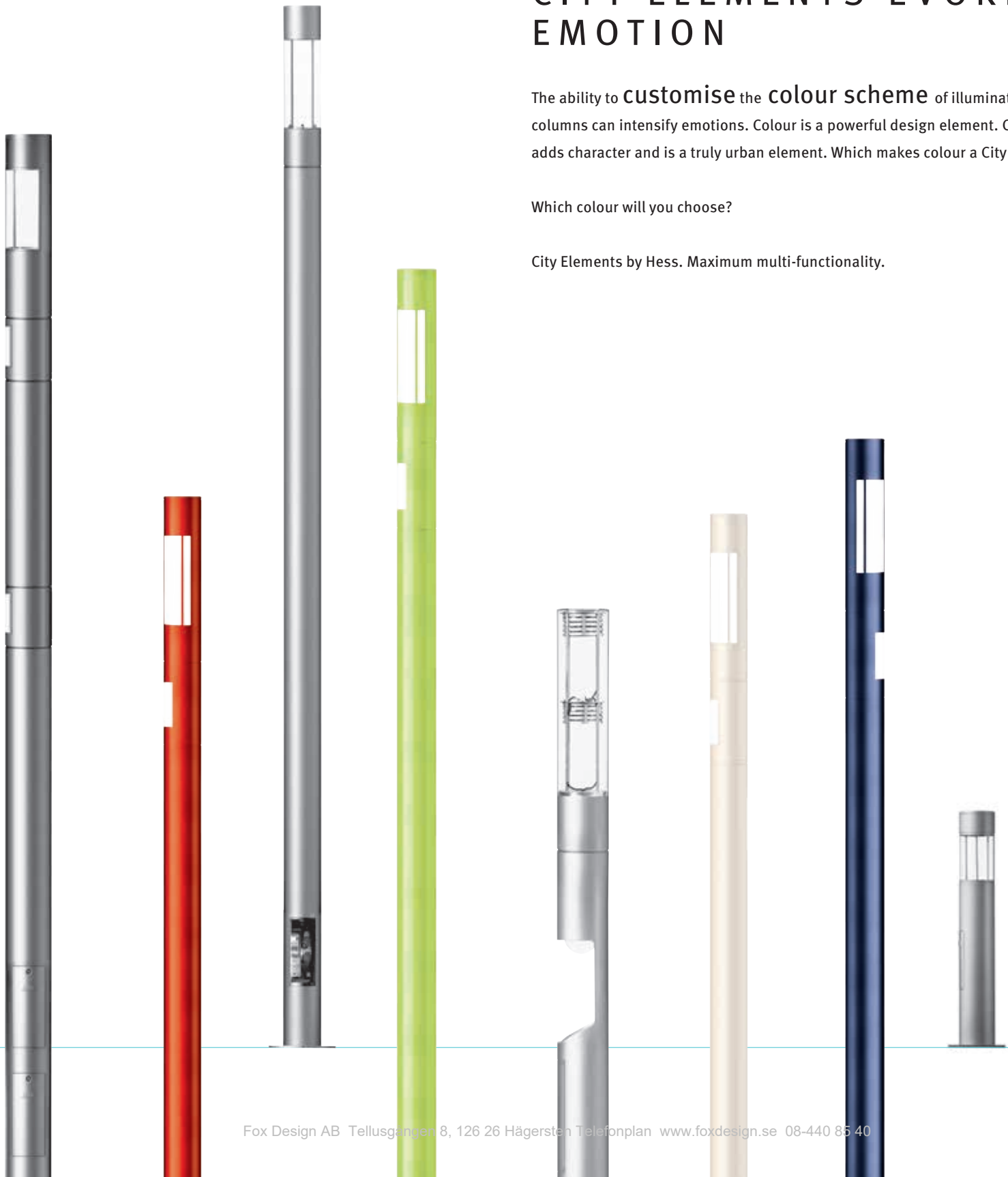

VAREDO – BY HESS

In the shape of VAREDO, we have created an entirely new generation of luminaires and site furnishings. A generation of solutions that gives landscape architects and lighting designers maximum freedom when arranging urban spaces.

A wide array of products within the same family and a host of different materials are available, but always with a high-quality appearance and feel. Further benefits include quality craftsmanship and a compelling design idiom. This is VAREDO.

From outdoor lighting and illuminating or barrier bollards to benches and waste receptacles: prepare to be inspired by VAREDO.

VAREDO – By HESS.

Time for something exceptional.

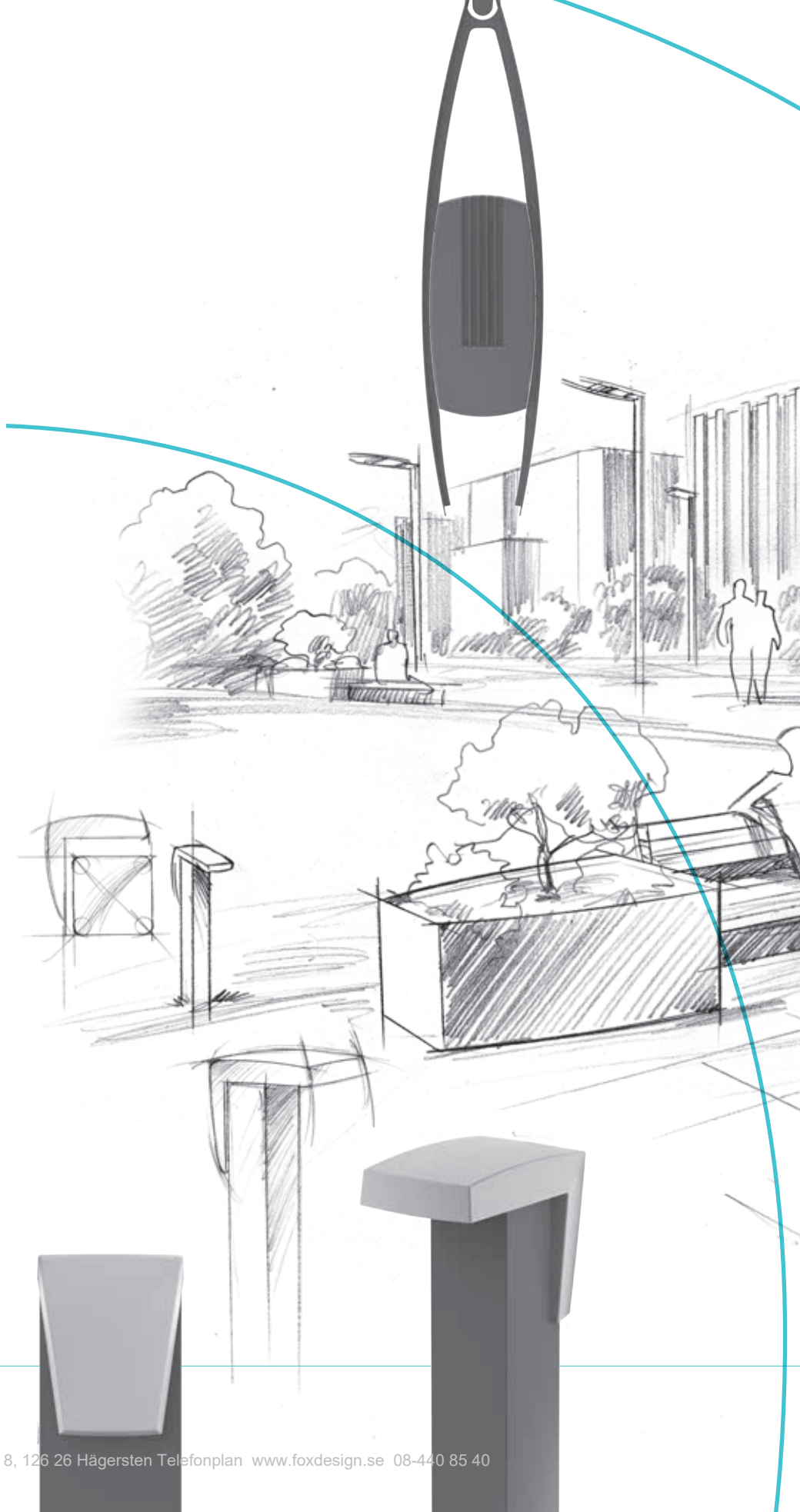

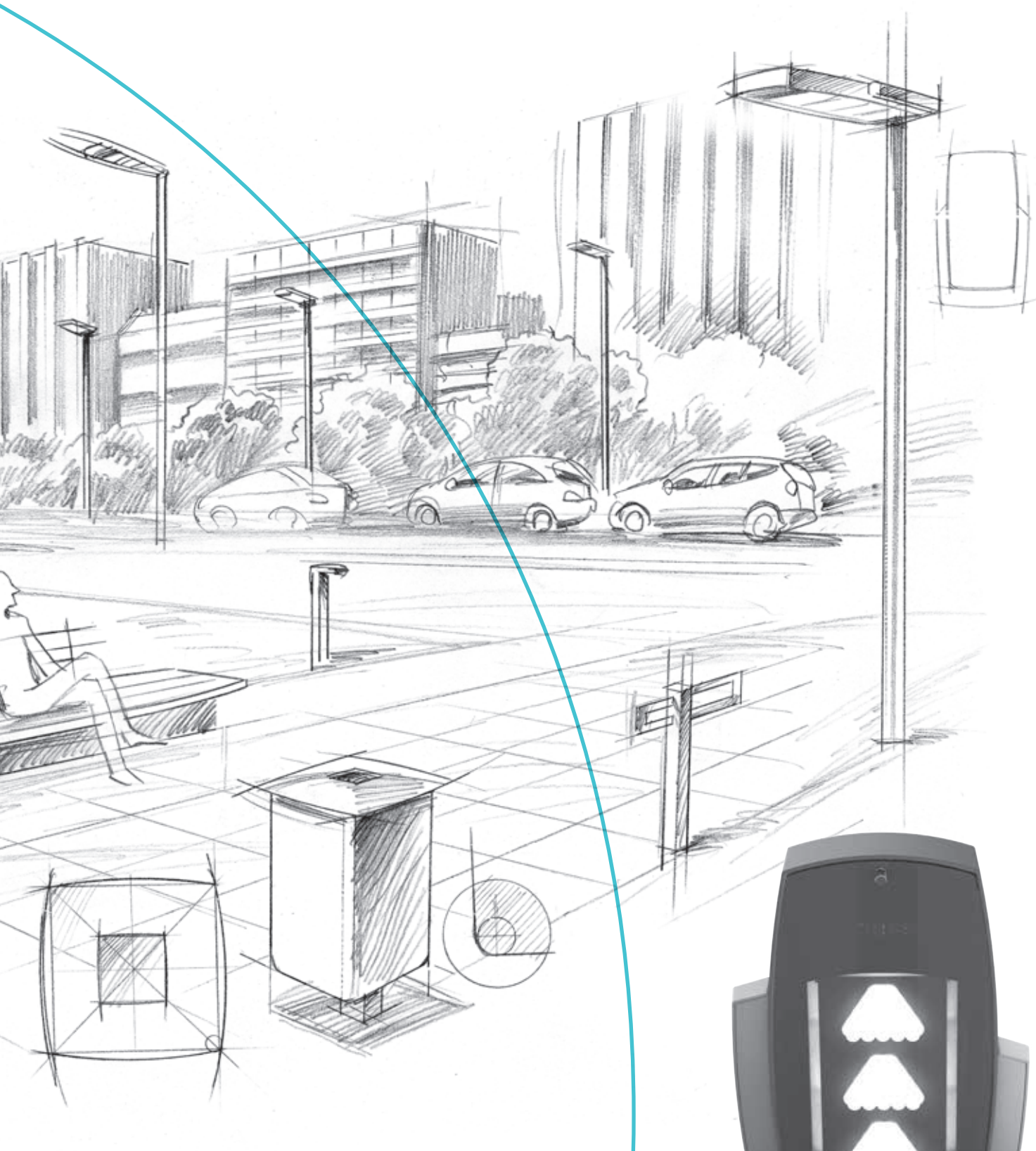

WASTE RECEPTACLES



Stainless steel



Galvanised sheet steel



FULLY FLEXIBLE COMBINATIONS - VAREDO

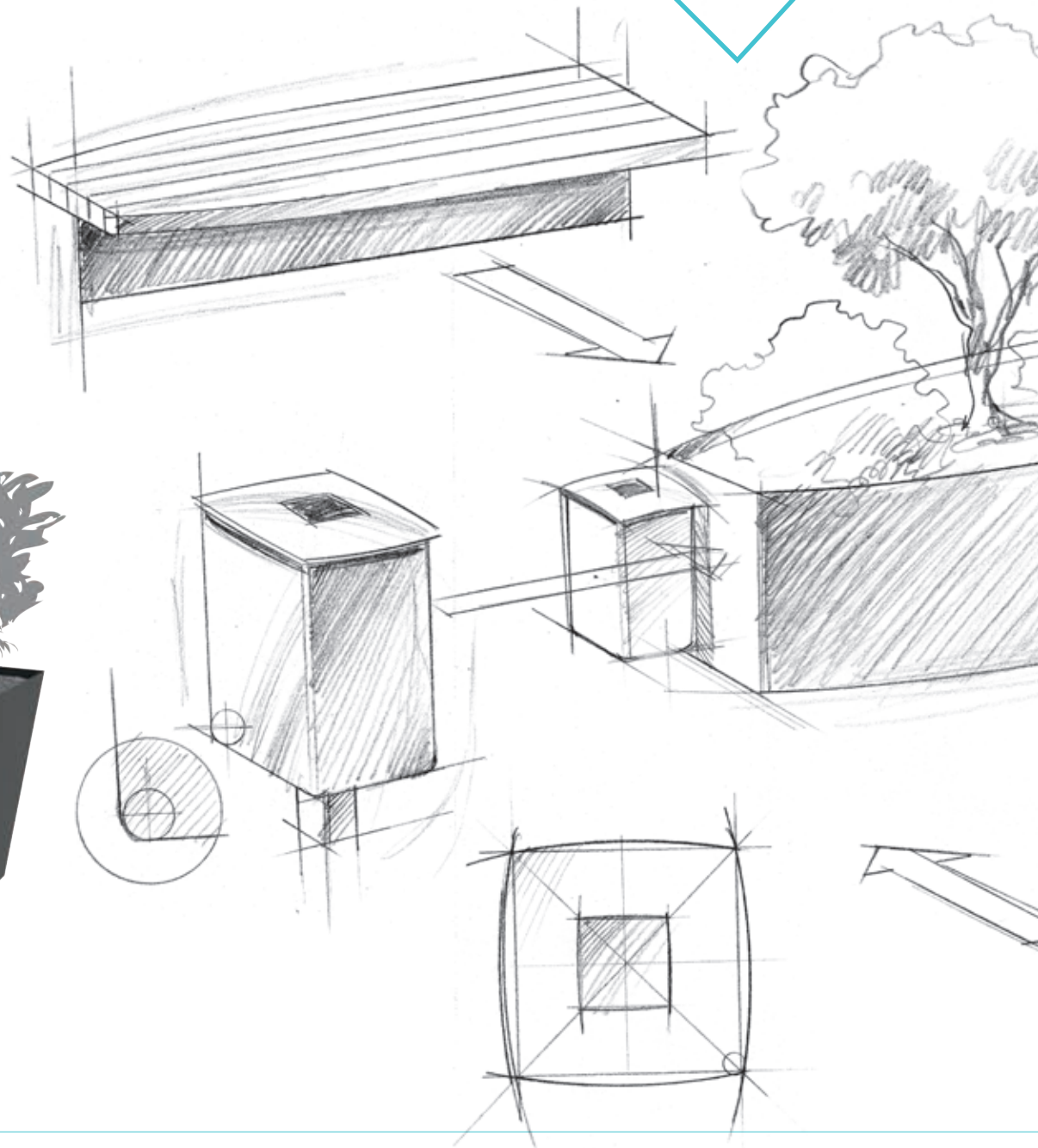

How would you like your bench?

Short or long? With an inbuilt waste receptacle? Or perhaps a planter?

Or combined with a bicycle rack? The choice is yours. It remains one (bench) system.

VAREDO By HESS.

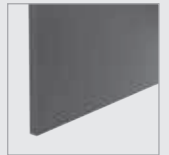
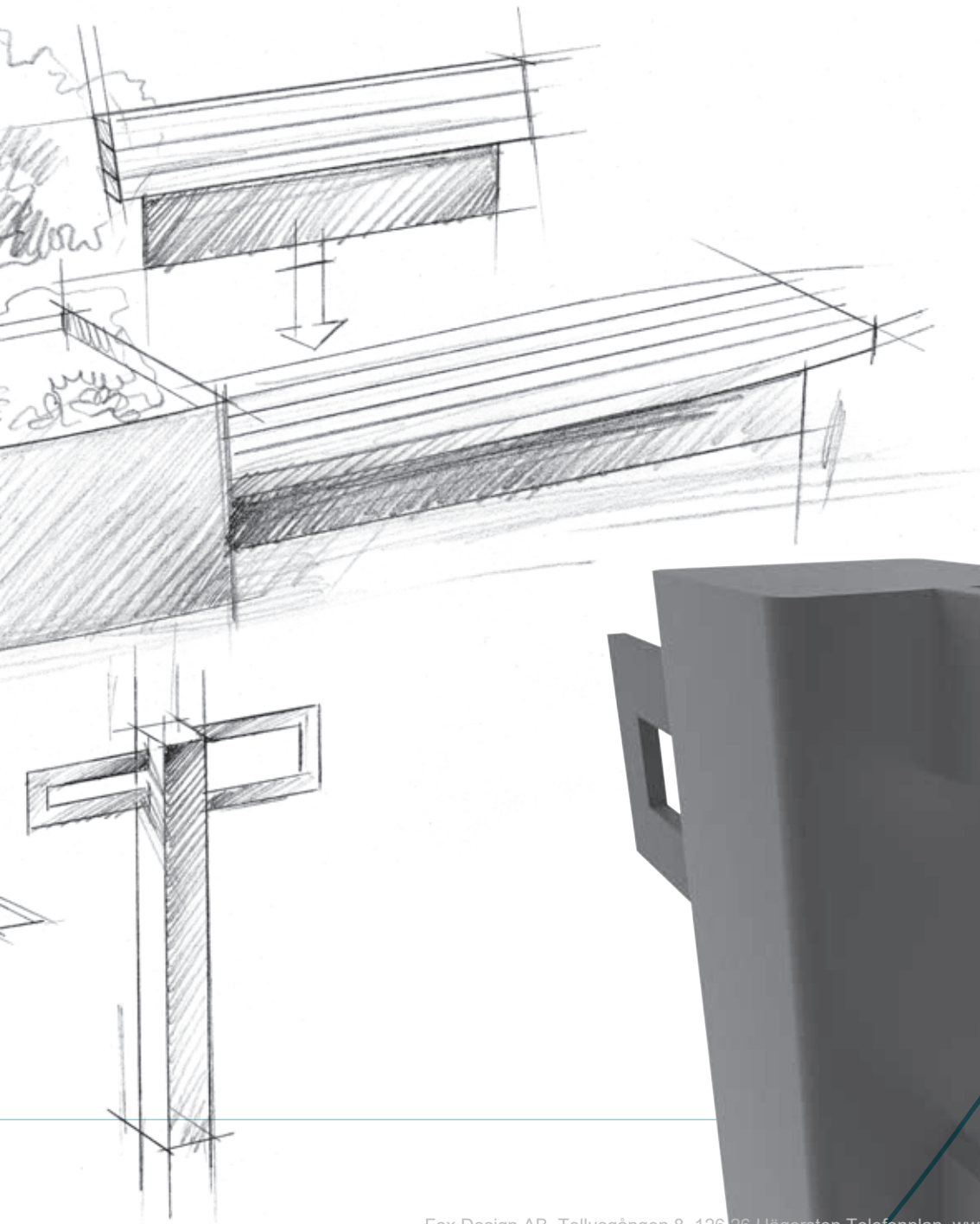

DB 703

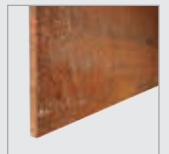

Corten steel



Ash



Pine

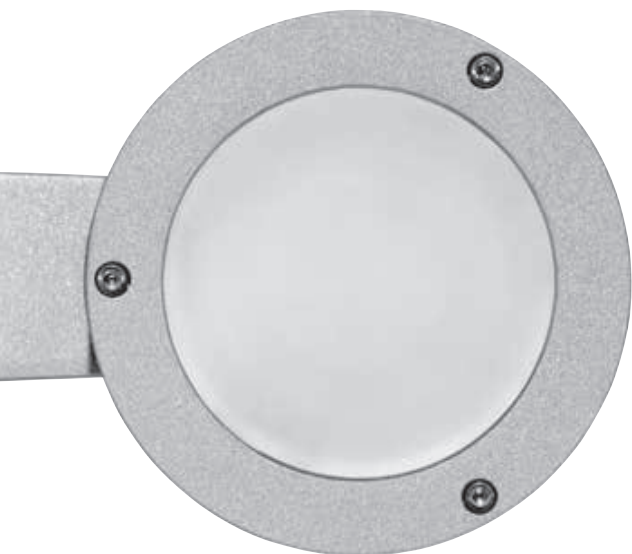

VARELLO

SOPHISTICATED LIGHTING CONCEPTS FOR BUILDINGS AND THE SURROUNDING AREAS

AVANGARDO 2 offers diversity in form, material and function.

The technology behind the Avangardo 2 collection has been further developed to give lighting designers, urban planners and architects **15 different luminaire families** to choose from in a range of high-quality treated surfaces. The special feature is that each luminaire family is comprised of several product groups – ranging from in-ground and wall luminaires to illuminating bollards – in an integrated and holistic design.

Value retention, durability and reliability are further key features. We use only the highest quality materials for our Avangardo luminaires, such as steel, aluminium and cast aluminium combined with borosilicate, polyacrylic or single-pane tempered safety glass.

**Predestined for integrated lighting concepts.
AVANGARDO 2 by Hess.**

PADUA



AVANGARDO

FERRARA

100%
LED

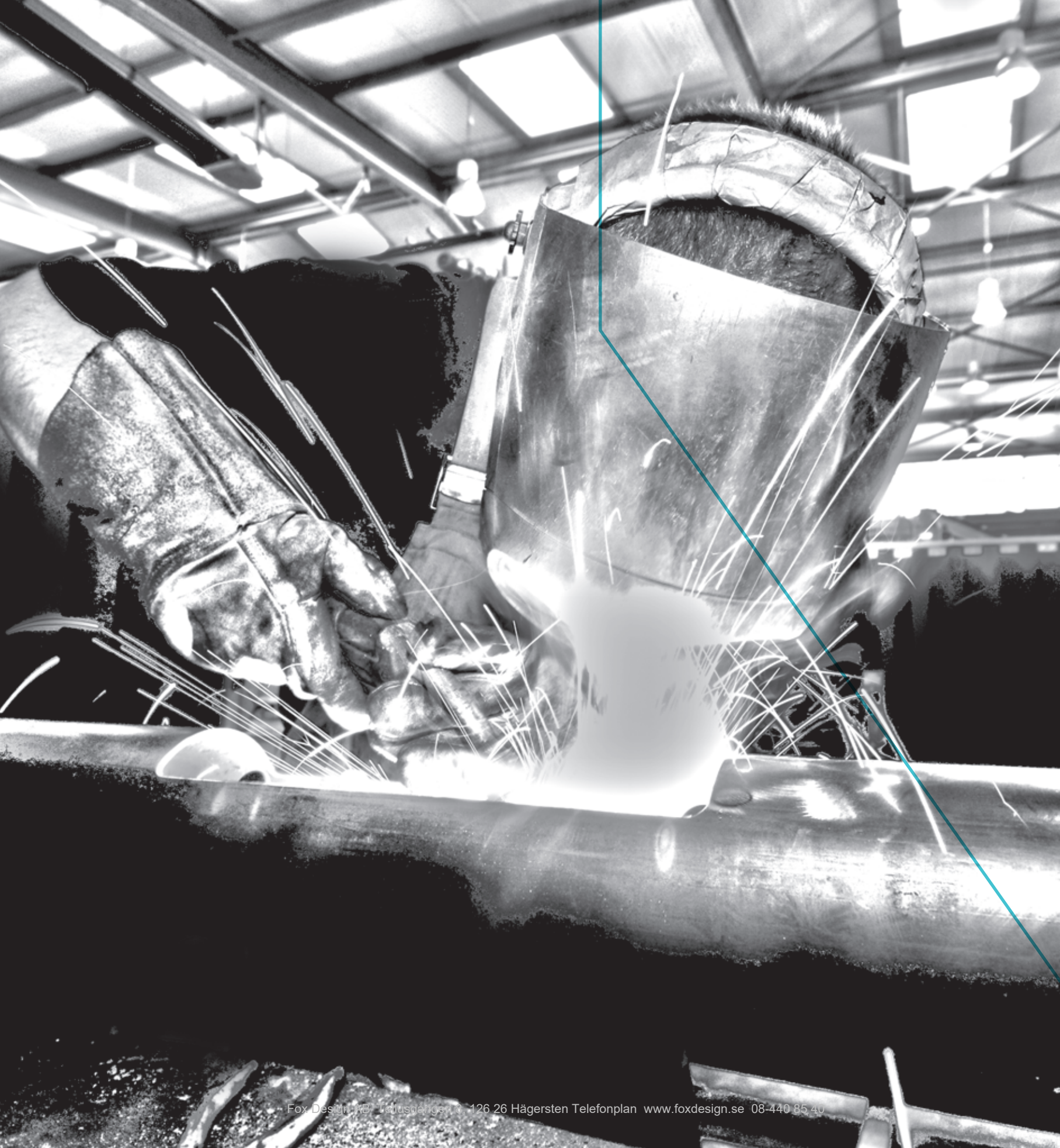

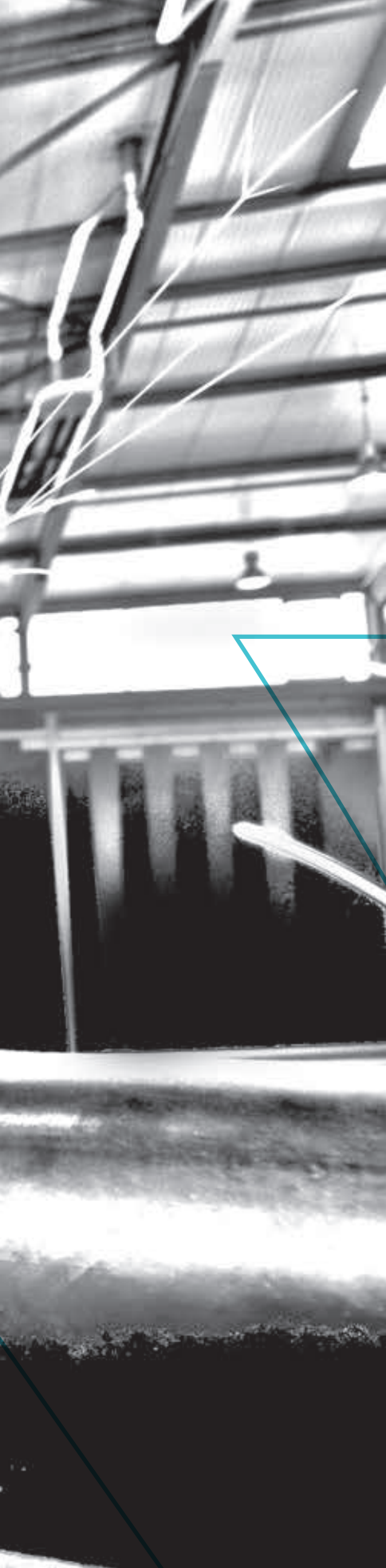

HESS. DESIGN AND INDIVIDUALITY

Innovative engineering meets professional craftsmanship from Germany's Black Forest. A perfect combination that enables virtually unlimited customisation and creativity.

Our **customised special solutions** are exceptional.
And designed for exceptional urban spaces. Creating an unexpected visual focal point, day and night.

SPECIAL luminaires, SPECIAL finishes, SPECIAL colours, SPECIAL glass.

SPECIAL solutions – MADE IN GERMANY - MADE BY HESS.

NORDEON GROUP

● Headquarters ■ Manufacturing ● Sales

1 NORDEON GROUP headquarters, Eindhoven (NL) . 2 NORDEON, Springe (DE)
2 Vulkan, Springe (DE) . 3 Hess, Villingen-Schwenningen (DE)
4 NORDEON, Chalon-sur-Saône/Dijon (FR) . 5 Hess America, Gaffney (SC/US)
6 Hess Scandinavia, Stockholm (SE) . 7 Hess Spain, Barcelona (ES)
8 Hess Belgium, Ghent (BE) . 9 InstallerDirect.com, Chalon-sur-Saône (FR), Springe (DE), Eindhoven (NL)

A 115-year-old newcomer

The Nordeon story began over 115 years ago, but gained new impetus in 2012.

The Nordeon Group – a new name in the lighting industry. Well-established. Agile with the strength of an “established newcomer”.

- 4 manufacturing locations
- approx. 650 employees
- over 115 years of experience

The lighting industry is undergoing intense change. Demand for energy efficiency is rising all the time, with efficient LED luminaires advancing in leaps and bounds. The Nordeon Group is helping to drive this development, while at the same time striving to conserve resources and advocating the use of energy-efficient LED lighting.

A proven track record

Nordeon became established in Springe, Germany, following the takeover of the production facility there from Philips in 2012. The Nordeon Group now brings together the high level of expertise and strong reputation of former Philips sites in Springe (Germany), Chalon-sur-Saône and Dijon (both in France) with two influential, established German companies specialising in outdoor lighting: Vulkan of Springe and Hess of Villingen. As a result, the Group is able to draw on over 115 years of experience.

Launched in April 2013, InstallerDirect.com is a highly innovative new venture – an online wholesale platform for lighting and lighting-related products aimed exclusively at installers.

Agile and customer-focused with a stable structure

The Nordeon Group is comprised of medium-sized, agile locations for manufacturing and innovation, which operate in close proximity to their customers and markets. The group’s aim is to pool and leverage the experience and capabilities of these individual companies, in order to offer customers maximum benefit and optimum service and performance.

We leverage synergies to benefit our customers and ensure a high level of stability.

You can rely on us.

www.nordeon-group.com

FIDENZA

Product Information



Wall Mounted Luminaire www.hess.eu/2530



Illuminating Bollard www.hess.eu/2520

The FIDENZA luminaire family captivates with its aesthetic and slim design. Ideally suited for museums, public buildings and as pathway lighting. For all situations where a streamlined and modern look is desired and a luminaire needs to create more than just light. FIDENZA is a luminaire with appeal – during day and night.



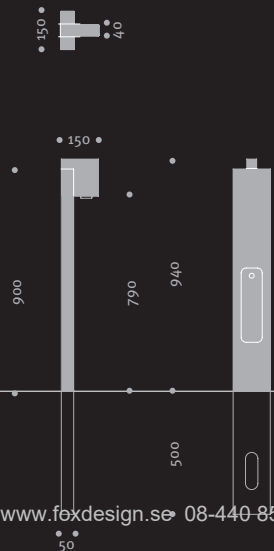
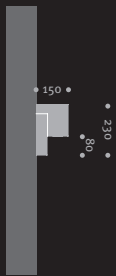





PADUA

Product Information



Wall Mounted Luminaire www.hess.eu/2570



Illuminating Bollard www.hess.eu/2560

Round luminaire body, rectangular luminaire support. For the PADUA product family, the classical combination of shapes was foregone. As a result, this luminaire has become a real highlight and at the same time, more than exceeds the high energy efficiency and illumination requirements.



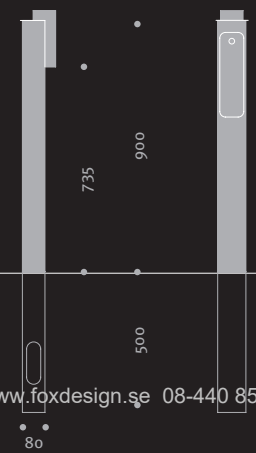
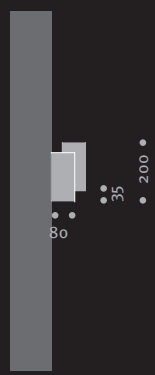





GENUA

Product Information



Wall Mounted Luminaire www.hess.eu/2550



Illuminating Bollard www.hess.eu/2540

Thanks to its modern minimalist design the GENUA product family achieves a visual lightness that allows the implementation of all kinds of lighting situations. Three available light colours and up to 12 LEDs, make this luminaire extremely diverse and thus ideally suited for various illumination requirements and situations.

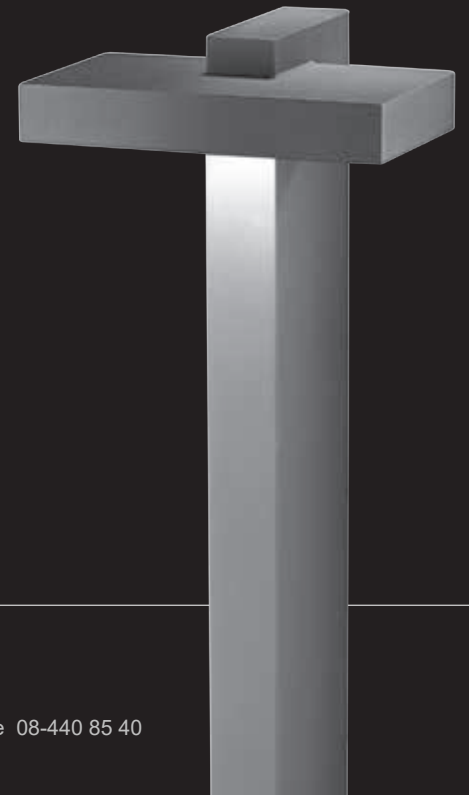

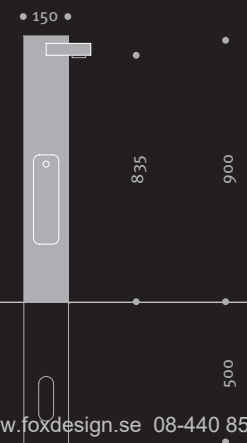
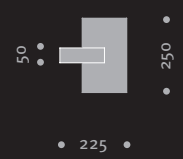
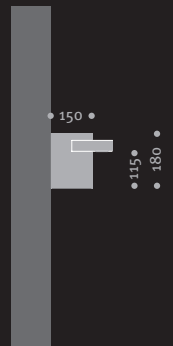
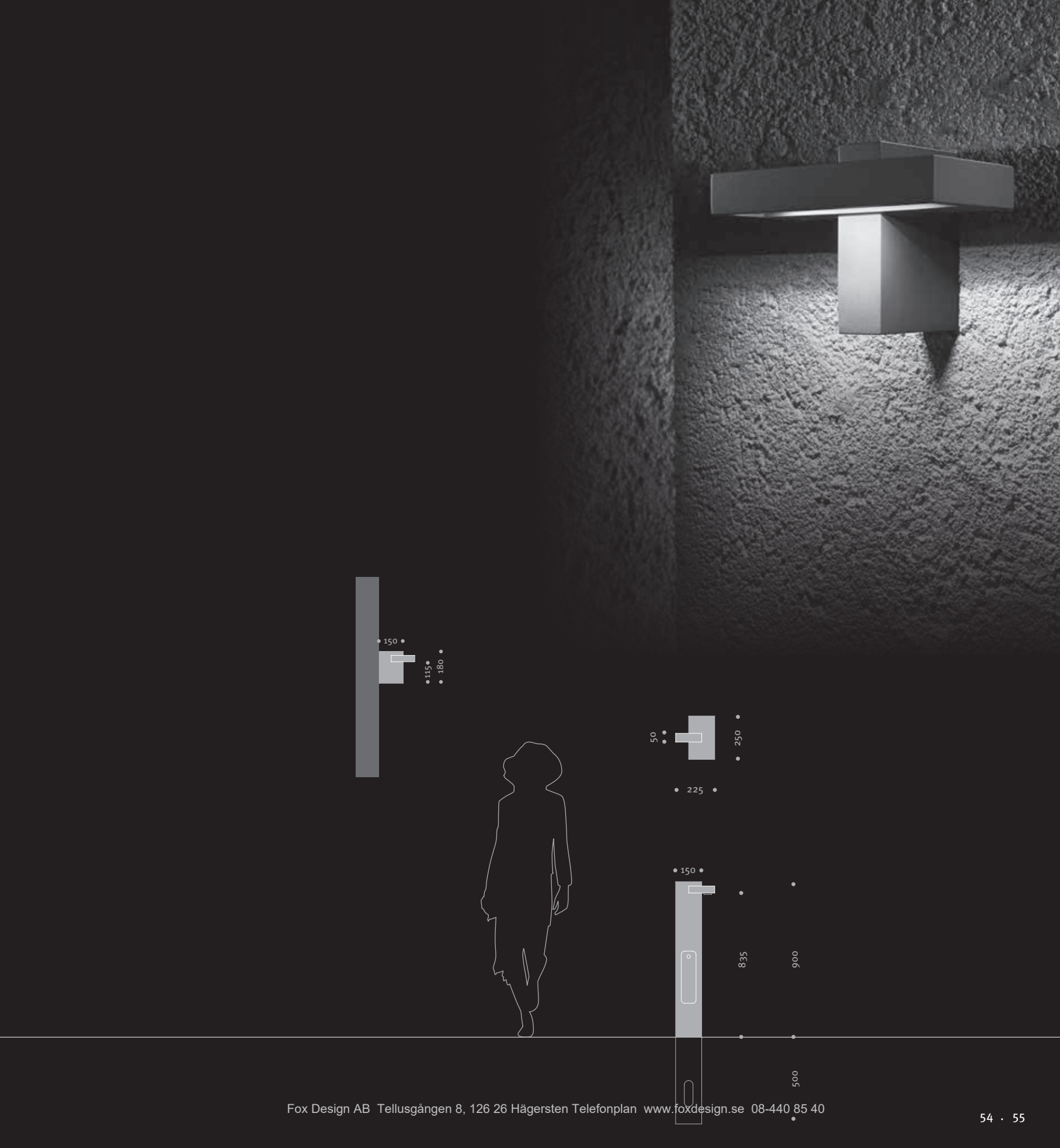





CARINI

Product Information



Wall Mounted Luminaire www.hess.eu/2510



Illuminating Bollard www.hess.eu/2500

The combination of various shapes characterises the look of the CARINI product family. The spherical luminaire body fits harmoniously into the basic housing and allows for a great variety of extraordinary structural combination to be created.



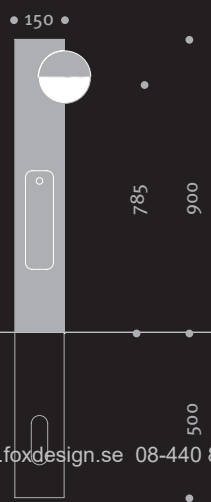
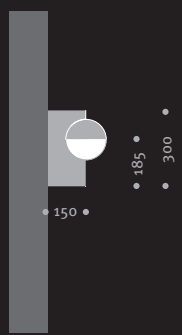





FERRARA

Product Information



Wall Mounted Luminaire www.hess.eu/5511



Illuminating Bollard www.hess.eu/7011

One distinguishing feature of the FERRARA family of luminaires is its square housing made from frosted polyacrylic glass, framed by aluminium plates. The soft light provides pleasant ground-level lighting. The combination with the wall luminaire from the same product family delivers a consistent design for various lighting situations indoors and out.



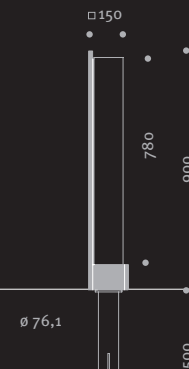
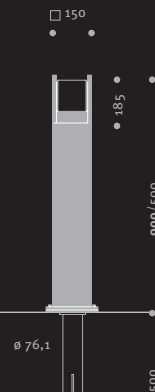
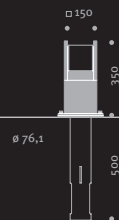
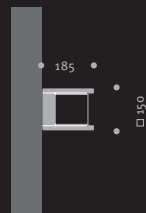



A57

MAN-Academy
Service-Training



CENTO

Product Information



Wall Mounted Luminaire www.hess.eu/5522



Illuminating Bollard www.hess.eu/7022

Ingenious design, powerful delivery: The CENTO family of luminaires combines high-quality design requirements with pioneering LED technology. The lateral light outlet of the cylindrical aluminium luminaire housing ensures a homogeneous surround illumination. The illuminating bollard is available in various sizes and designs, with either a 180 mm or 760 mm light outlet, giving planners plenty of design freedom. The LED model is directly linked to the luminaire housing for optimum thermal management.



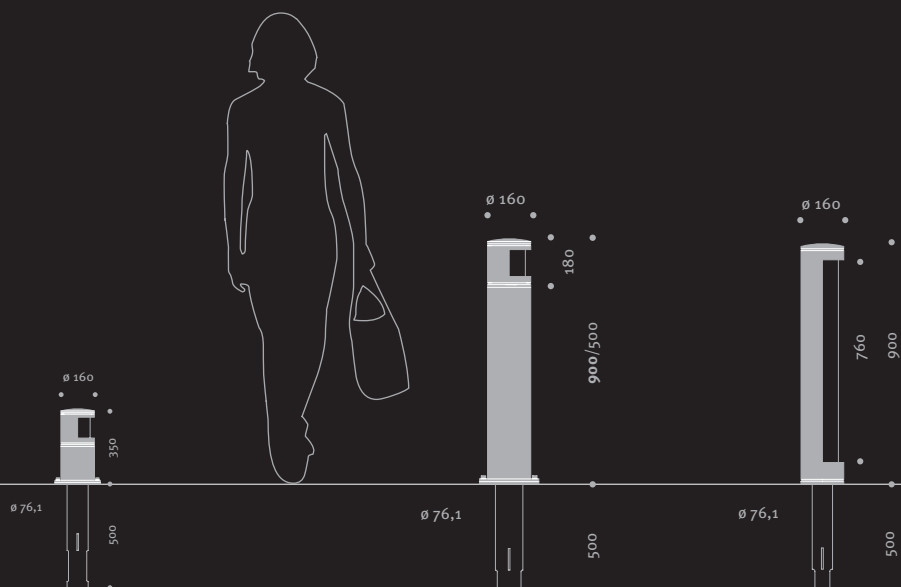
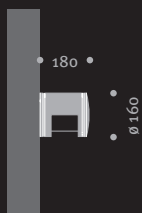
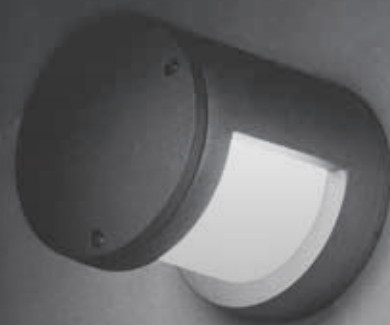



CASSINO

Product Information



Wall Mounted Luminaire www.hess.eu/5501



Illuminating Bollard www.hess.eu/7001

The cube-shaped, satin-finished polyacrylic glass housing of the CASSINO products is only limited on one side by an aluminium plate and provides paths and rooms with atmospheric lighting. The straight lines of the CASSINO products are particularly well suited to modern buildings. Identical wall luminaires can additionally be used for prestigious outdoor solutions.



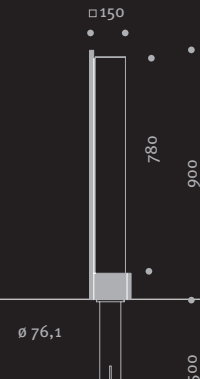
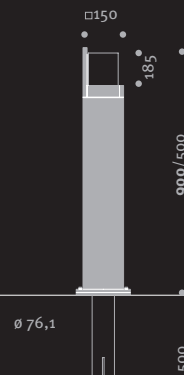
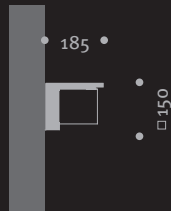





TRENTO

Product Information



Wall Mounted Luminaire www.hess.eu/5533



Illuminating Bollard www.hess.eu/7033

The cylindrical design of the TRENTO luminaire family creates decorative lighting effects. A ring made of anodised aluminium limits the 360° emission of light and focuses it on the immediate surroundings. Paths and building entrances can be skilfully illuminated.



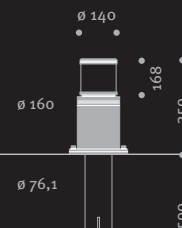
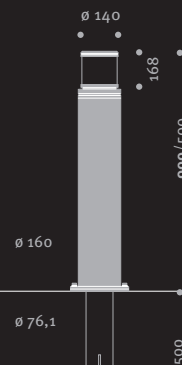
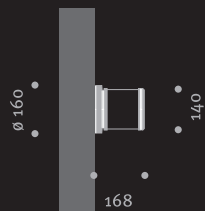
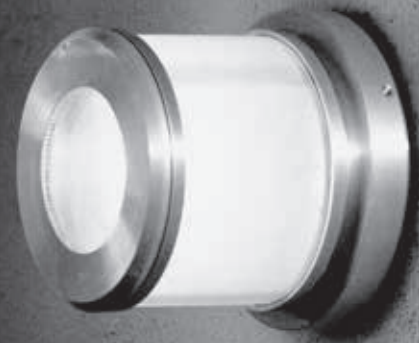





AMALFI

Product Information



Wall Mounted Luminaire www.hess.eu/5022



Illuminating Bollard www.hess.eu/7066

These are real gems for entrances, passages and historically unique buildings. The Amalfi illuminating bollard is designed as a torch light with luminaire shade, proving that modern LED technology and nostalgic design can be a perfect match



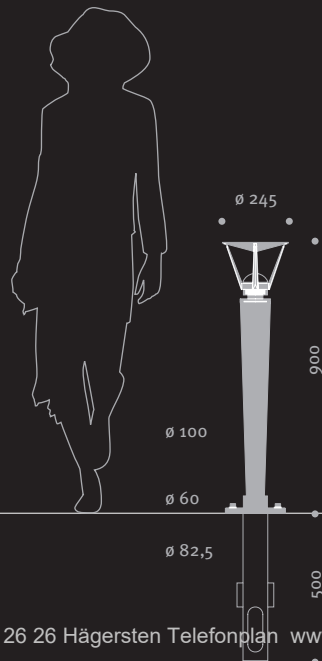
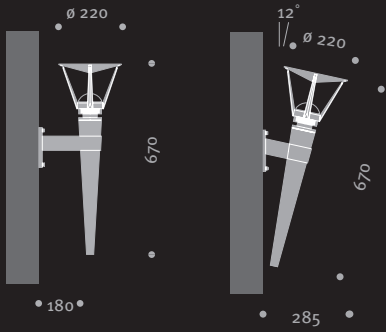





PARMA

Product Information



Wall Mounted Luminaire www.hess.eu/5011



Illuminating Bollard www.hess.eu/7040

The highly varied models of the PARMA product family are a modern interpretation of classic torch lights. The eye is caught by the tapered, satin-finished luminaire glass on a conical bollard made from lacquered cast aluminium. They are ideal for effective outdoor lighting applications. This product family can, for example, produce a consistent lighting solution for green spaces.



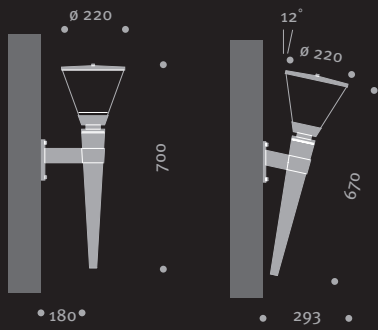





RIVA

Product Information



Wall Mounted Luminaire www.hess.eu/5033



Illuminating Bollard www.hess.eu/7133

Whether used as outdoor lighting, as a wall luminaire or as an illuminating bollard, the RIVA model perfectly sets off both historic and modern architectonic backdrops. Its torch-like shape with frosted glass cover is particularly well suited for outdoor applications.



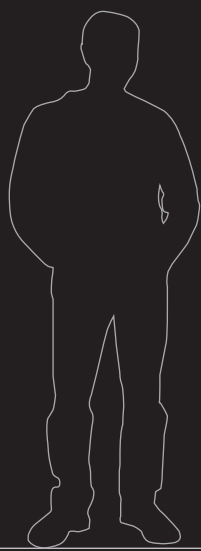
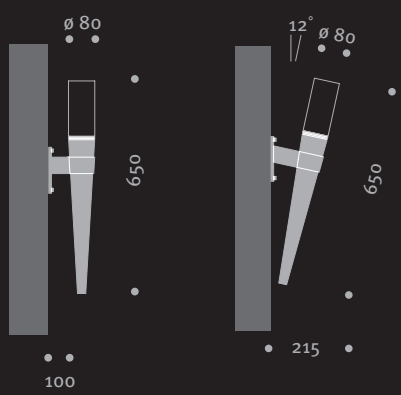





CERRITOS LIBRARY

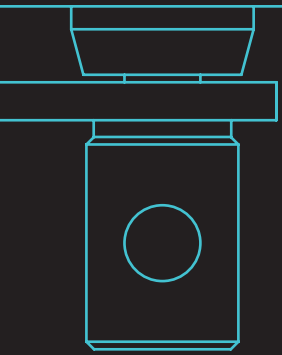
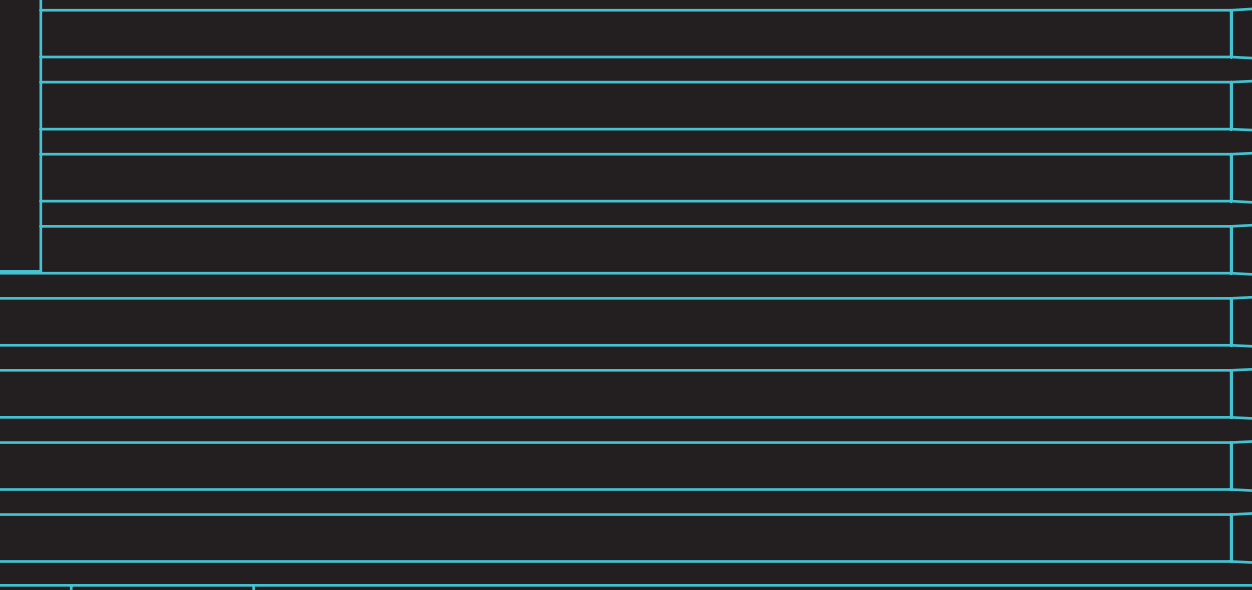

NOVARA L . V

Product Information



Wall Mounted Luminaire www.hess.eu/5100



Illuminating Bollard www.hess.eu/7101

Public spaces and buildings need lighting concepts that are both functional and attractive at the same time. The NOVARA luminaire series meets these requirements. Wall luminaires, illuminating bollards with one or two luminaires, and bracket-mounted luminaires provide planners with enough models for various lighting situations.

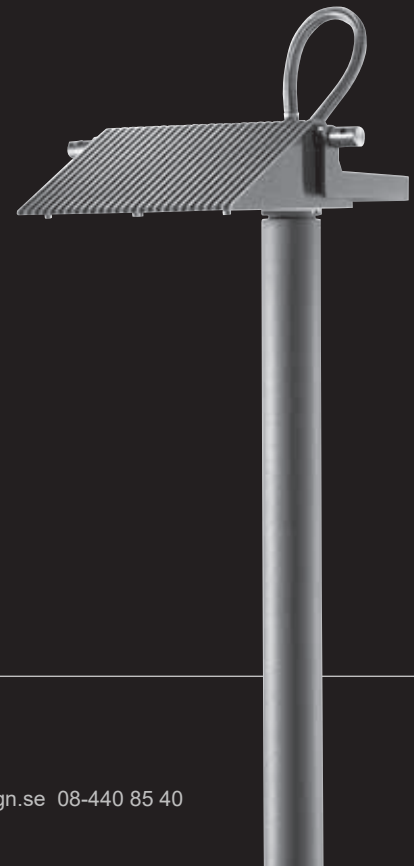

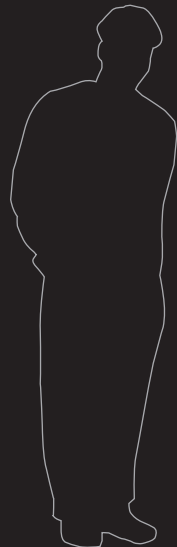
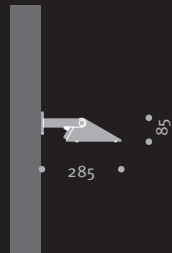







SALINA

Product Information



Wall Mounted Luminaire www.hess.eu/5122

Among the luminaires surface-mounted on walls, the minimalist SALINA model provides extra scope for individual design. Available with a frosted single-pane tempered safety glass on request, logos or signage information on the glass can be backlit. The glass is illuminated indirectly by the LED module that is integrated in the cast aluminium luminaire body.

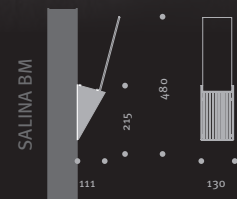
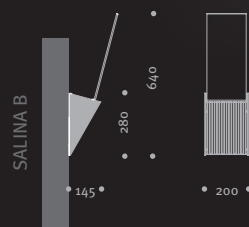
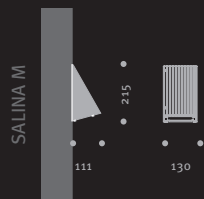
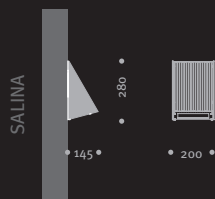





BARI 80

Product Information



Ceiling Mounted Luminaire www.hess.eu/1120

The BARI 80 models were developed especially for fitting to suspended ceilings. Cooling fins on the side of the cylindrical luminaire housing ensure optimum dissipation of heat. Hess also provides surface-mounting housings for non-suspended ceilings.



BARI 80



BARI 80 B GLAS

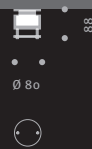

BARI 80 B METALL

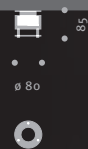

BARI 80 WV

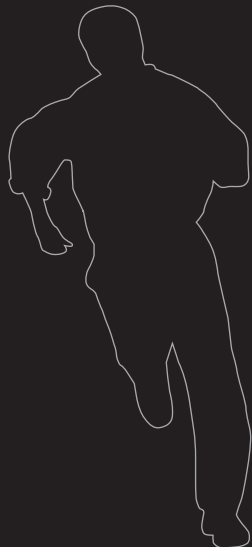
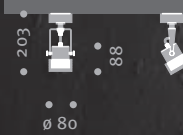

BARI 130

Product Information



Ceiling Mounted Luminaire www.hess.eu/1130

Intended for use both indoors and out, the simple BARI 130 luminaires come in different shapes and fit seamlessly into any architectonic surroundings. Cooling fins dissipate the heat over the entire luminaire housing.



BARI 130



BARI 130 B GLAS



BARI 130 B METALL



BARI 130 A



BARI 130 WV

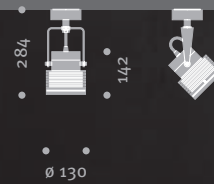

BARI 130 V

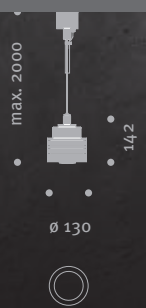





MESSINA 80/150

Product Information



Ceiling Mounted Luminaire www.hess.eu/1170

The MESSINA series is characterised by a cylindrical luminaire enclosure made from frosted polyacrylic glass. Available as a ceiling, pendant, or wall luminaire for suspended and non-suspended ceilings, its elegant design offers numerous ways of achieving a coherent lighting solution.

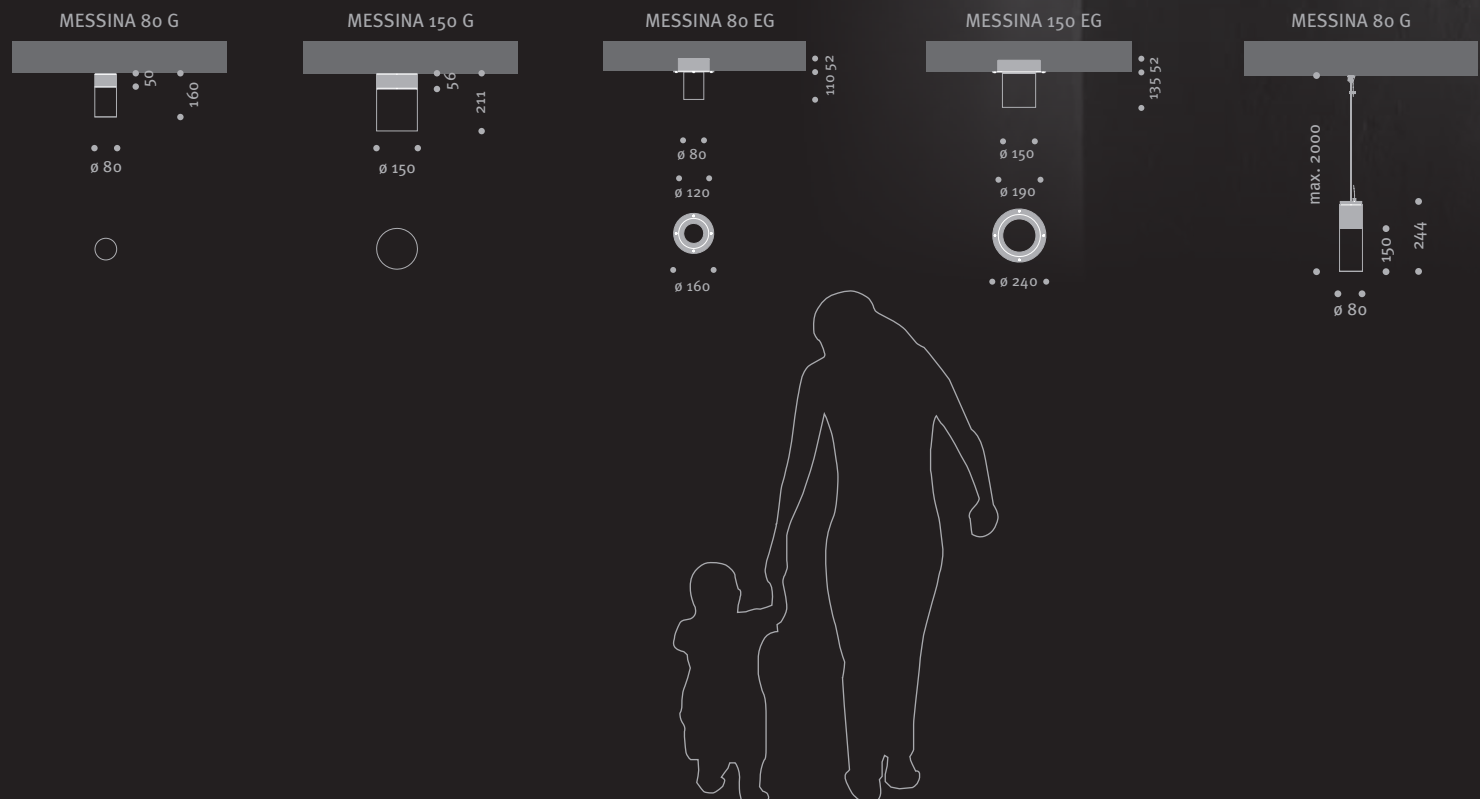





SAVONA

Product Information



Wall Mounted Luminaire www.hess.eu/5777

The grooved optics of the SAVONA luminaire surface-mounted on the wall make it a great instrument for effectively illuminating passages and corridors. Equipped with the Acrich LED module, it is renowned for its incredible energy efficiency.

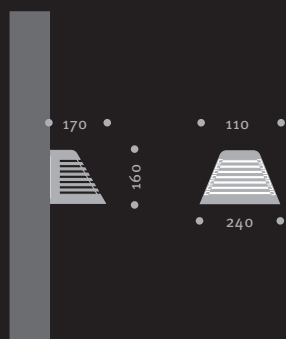

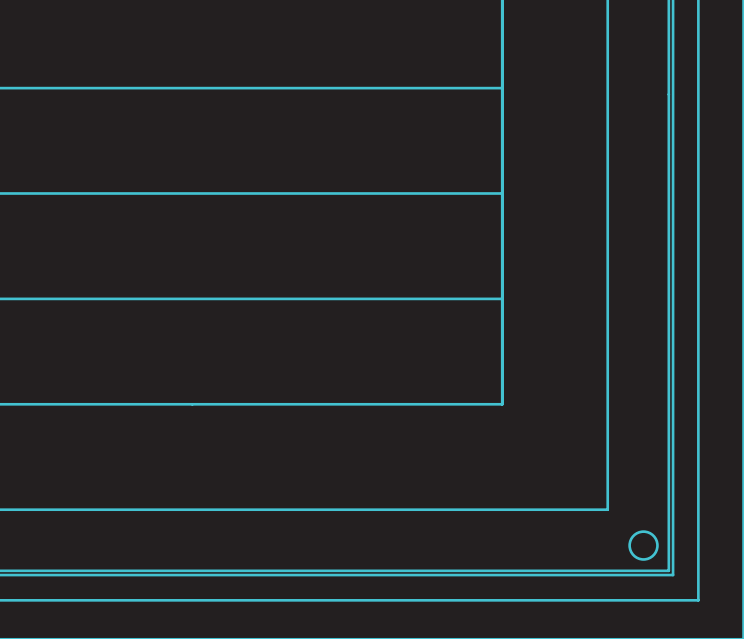

SEDI Q/R

Product Information



Recessed Wall Luminaire www.hess.eu/5540

The glare-free SEDI R and SEDI Q luminaires flush-mounted on the wall are ideal for lighting staircases and steps thanks to their characteristic shape. The cast aluminium luminaire housing is very robust and has distinctive optics.



- □ 147 •
- □ 240 •

265 x 238



- 145 •
- 148 •



- 397 •
- 490 •

- 147 •
- 240 •

265 x 488



- 145 •
- 148 •







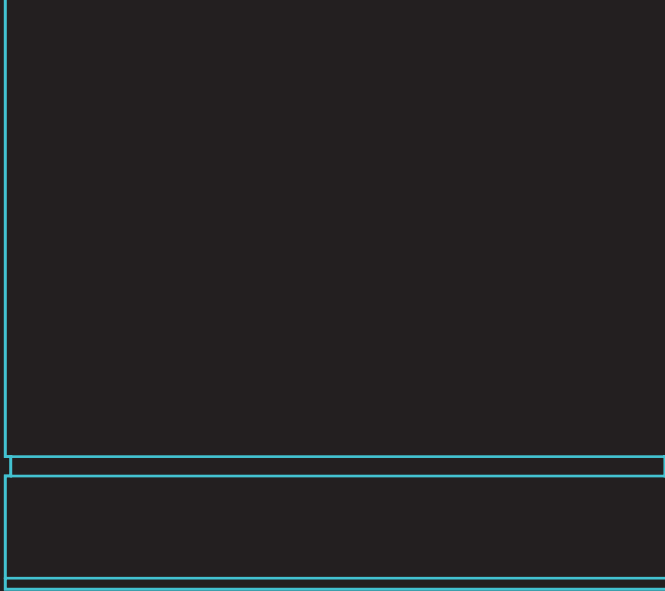

VARELLO

Product Information



Wall Mounted Luminaire www.hess.eu/5400

Available in four separate model variants, the VARELLO series has the perfect luminaire surface-mounted on the wall for all situations. Pick from various designs – with either one, two or three light outlet openings, with or without face end PMMA luminaire enclosure – and various dimensions between 300 mm and 550 mm. They offer flexible use in customised indoor and outdoor lighting solutions.

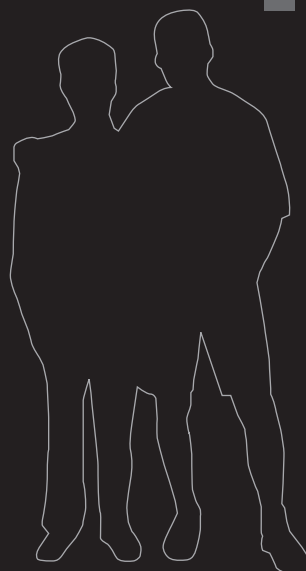
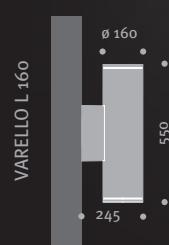
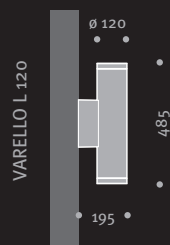
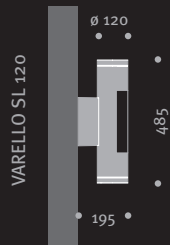
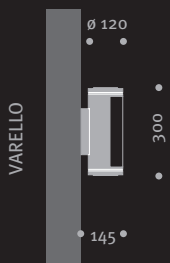





ARCUS

Product Information



Wall Mounted Luminaire www.hess.eu/1101

Designed to effectively present staircases, footpaths and passages for pedestrians and vehicles, the compact square flush- and surface-mounted wall luminaires of the ARCUS family emphasise the architectonic features of these areas. The single-pane tempered safety glass (ESG) on the luminaire enclosure is available in a variety of different surfaces.



ARCUS G



• □ 256 •



• 130 •

ARCUS GA



• □ 212 •
• □ 256 •



• •
131







LEDIA Q/R

Product Information



Recessed Luminaire www.hess.eu/8060

Fascinating lighting effects on buildings or paths can be created with the square/round flush-mounted luminaires in the LEDIA Q/R series. Small sizes for flexible use on walls or the ground. The high light yield produces ingenious lighting. LEDIA Q/R withstands even the most challenging usage conditions: The luminaires can even withstand wheel loads of 1.5 t.



Ø 36



□ 36







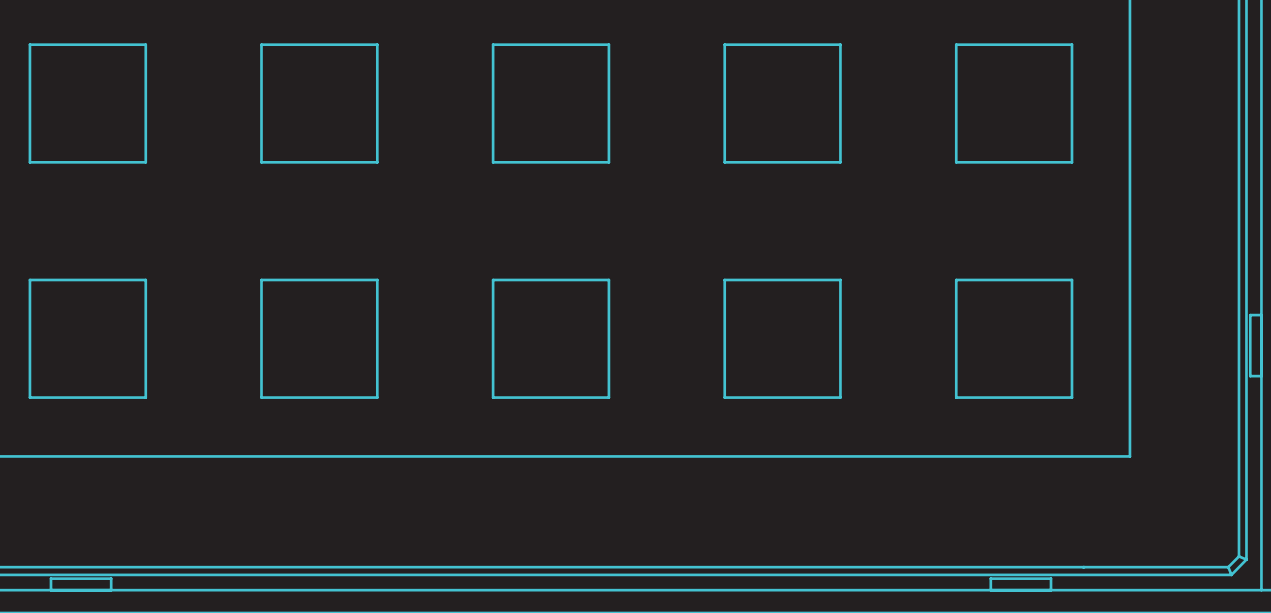

LEDIA LF

Product Information



Illuminating Tile www.hess.eu/8051

Illuminating tiles from the LEDIA LF family provide numerous ways of creating effect lighting. Four different sizes and six light colours ensure colour-intensive indoor and outdoor lighting effects. The single-pane tempered safety glass (ESG) has a non-slip surface.

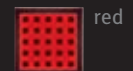

red



warmwhite



coldwhite



orange



green

blue

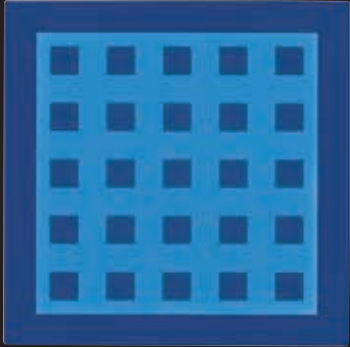

LEDIA LF OD

□ 95/195/295/395

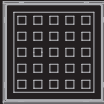

LEDIA LF ID

□ 95/195/295/395

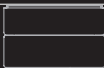
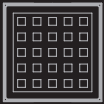

59
120



60-140

LEDIA LL

Product Information



Illuminating Strip www.hess.eu/8011

The bar-shaped illuminating strips in the LEDIA LL product family are just 28 mm wide and ensure impressive lighting effects. Suited to both indoor and outdoor use, they effectively highlight fountains, the steps on staircases and public spaces. The use of LEDs with RGB technology in the strips provides plenty of colour.

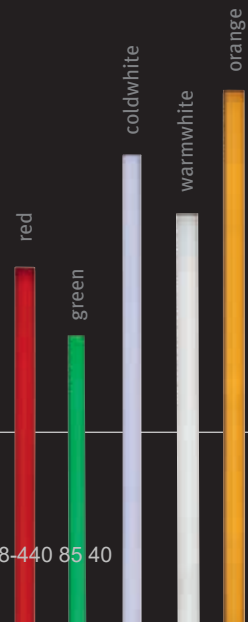

blue

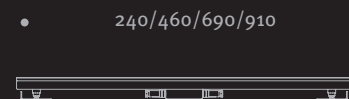
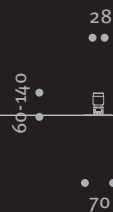
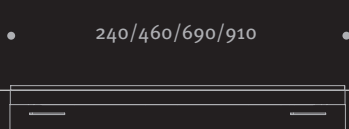





RAVENNA

Product Information



In-ground luminaire www.hess.eu/6100

Customised lighting concepts using efficient spotlights ensure the visual accentuation of architectural highlights. Ravenna in-ground luminaires, available with various half-peak divergences and in part with variably swivelling luminaries, comprehensively cover this range of applications. Thanks to an especially developed thick coating, the RAVENNA luminaires are particularly weather resistant. Robust and high-quality materials ensure a long product life.



RAVENNA G 110



Ø 110



200

RAVENNA G 220



Ø 230

Ø 220

Ø 170



345





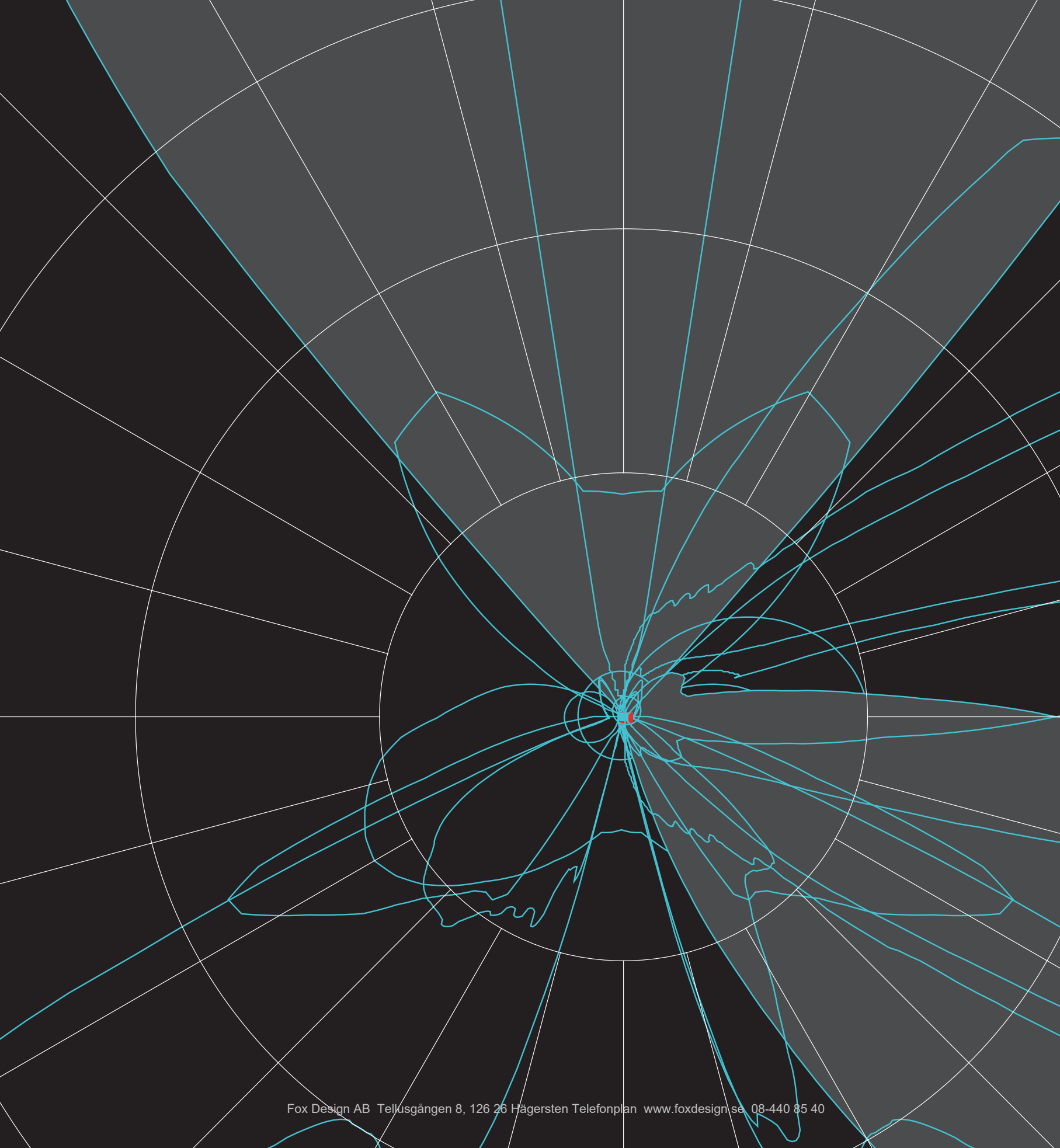

TECHNICAL INFORMATION

THE QUICK AND EASY WAY TO THE TECHNICAL PRODUCT DETAILS.

The quick and easy way to the technical product details:
www.hess.eu



Daily updated data sheets for all products are available on the Hess website. They include all relevant performance informations for LED-equipment.



IT'S THIS EASY

- www.hess.eu
- find product via search engine or navigation
- or product direct link, e.g. www.hess.eu/1082
- download technical data sheet from „Documents“

HERE YOU WILL FIND THE DIALUX LUMINAIRE PLUGIN

- www.hess.eu/dialux

Imprint

Concept, Design & Typesetting

ZWEI14 GmbH
www.zwei14.de

Photography

Ralf Ganter, Maik Goering, Hans-Jürgen Haffa,
Stefanie Heublein, Die Arge Lola,
Johann Lichtl, hess Archiv, Max Schulz

Printing

Holzer Druck und Medien

Print Run

1st Edition, April 2014





Hess GmbH

Licht + Form

Lantwattenstraße 22

D 78050 Villingen-Schwenningen

Tel. + 49 (0) 7721 920-0

E-mail: info@hess.eu

www.hess.eu

For a listing of Hess sales offices
and the nearest sales agent, visit:
www.hess.eu/o100

.hess

All rights reserved.

© Hess GmbH Licht + Form . ZW.04/14.1.Hd
1st Edition, April 2014